

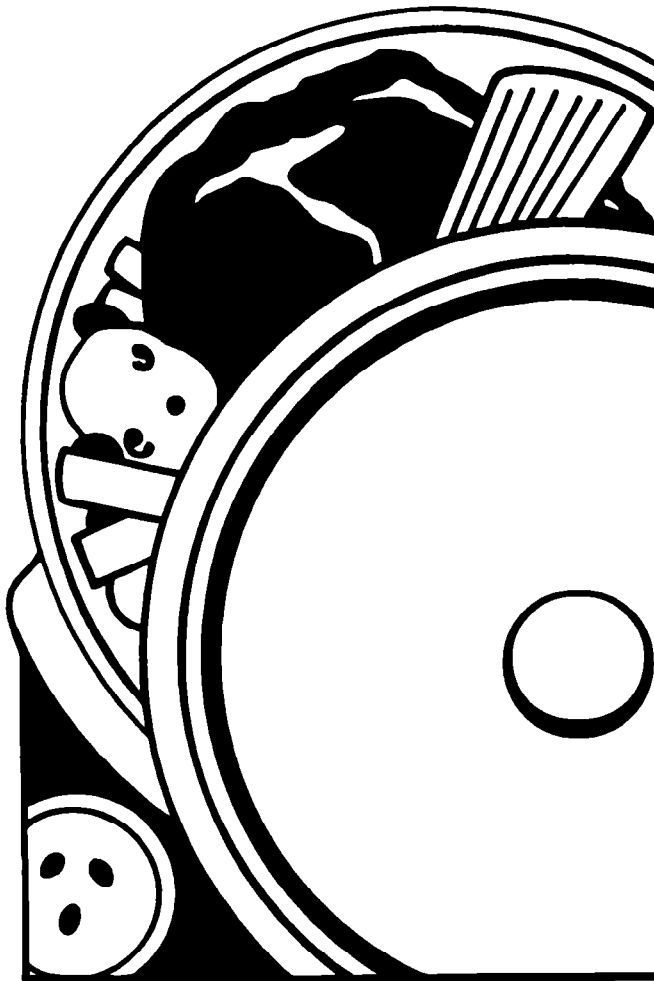

HOW TO MAKE A HOME BETTER™

Use And Care

G U I D E



| | |
|---|----|
| Table of Contents | 2 |
| A Note to You | 3 |
| Microwave Oven Safety | 4 |
| Installation Instructions | 9 |
| Getting to Know Your Microwave Oven | 11 |
| Cooking with Microwaves Only | 27 |
| Cooking with the Grill Element | 47 |
| Caring for Your Microwave Oven | 55 |
| Cooking Guide | 57 |
| Questions and Answers | 61 |
| Troubleshooting | 63 |
| Requesting Assistance or Service | 65 |
| Index | 67 |
| Warranty | 68 |

1-800-253-1301

Call us with questions or comments.

VIPcrispwave™ MICROWAVE OVEN WITH GRILL ELEMENT

PART NO. 461969404801/4375205

MODEL MG8120XD

Table of Contents

| | | | |
|--|----|--|----|
| A Note to You | 3 | Auto cook chart | 36 |
| Microwave Oven Safety | 4 | Using AUTO DEFROST | 37 |
| Important safety instructions | 4 | Auto defrost chart | 39 |
| Precautions to avoid possible exposure to excessive microwave energy | 6 | Defrosting tips | 40 |
| Operating safety precautions | 7 | Using AUTO REHEAT | 41 |
| Installation Instructions | 9 | Auto reheat chart | 42 |
| Getting to Know Your Microwave Oven | 11 | Using POPCORN | 43 |
| How your microwave oven works | 11 | Using WARM HOLD | 44 |
| Microwave oven features | 13 | Using SIZZLE | 45 |
| Control panel features | 14 | Cooking with the Grill Element | 47 |
| Utensils | 17 | To get the best cooking results | 47 |
| Built-in kits | 18 | Using CRISP | 48 |
| Setting the clock | 18 | Using AUTO CRISP | 50 |
| Using the Minute Timer | 19 | Auto crisp chart | 52 |
| Changing cooking times | 20 | Using GRILL | 52 |
| Using ADD MINUTE | 24 | Choosing the proper utensil materials | 54 |
| Using COOK A BIT MORE | 24 | Caring for Your Microwave Oven | 55 |
| Using PAUSE | 25 | Cooking Guide | 57 |
| Using Personal Choice | 25 | Reheating chart | 57 |
| Cooking with Microwaves Only | 27 | Microwave cooking chart | 58 |
| To get the best cooking results | 27 | Cooking tips | 59 |
| Cooking at high cook power | 28 | Questions and Answers | 61 |
| Cooking at lower cook powers | 29 | Troubleshooting | 63 |
| Cooking with more than one cook cycle | 31 | Requesting Assistance or Service | 65 |
| Using AUTO COOK | 34 | Index | 67 |
| | | Warranty | 68 |

A Note to You

Thank you for buying a Whirlpool® appliance.

Because your life is getting busier and more complicated, Whirlpool microwave ovens are easy to use, save time, and help you manage your home better. To ensure that you enjoy years of trouble-free operation, we developed this Use and Care Guide. It is full of valuable information about how to operate and maintain your appliance properly and safely. Please read it carefully.

Also, please complete and mail in the Ownership Registration Card provided with your appliance. The card helps us notify you about any new information on your appliance.

Please record your model's information.

Whenever you call to request service for your appliance, you need to know your complete model number and serial number. You can find this information on the model and serial number plate (see diagram on page 13 for location of plate).

Please also record the purchase date of your appliance and your dealer's name, address, and telephone number.

Model Number _____

Serial Number _____

Purchase Date _____

Dealer Name _____

Dealer Address _____

Dealer Phone _____

Keep this book and the sales slip together in a safe place for future reference.

**Our Consumer Assistance Center
number is toll-free 24 hours a day.**

1-800-253-1301

Microwave Oven Safety

Your safety is important to us.

This guide contains safety statements under warning symbols. Please pay special attention to these symbols and follow any instructions given. Here is a brief explanation of the use of the symbol.

⚠WARNING

This symbol alerts you to such dangers as fire, electrical shock, burns, and personal injury.

IMPORTANT SAFETY INSTRUCTIONS

Microwave ovens have been thoroughly tested for safe and efficient operation. However, as with any appliance, there are special installation and safety precautions which must be followed to ensure safe and satisfactory operation and prevent damage to the unit.

⚠WARNING

To reduce the risk of fire, electrical shock, burns, injury to persons, exposure to excessive microwave energy, or damage when using the microwave oven, follow basic precautions, including the following:

- Read all instructions before using the microwave oven.
- Read and follow the specific "PRE-CAUTIONS TO AVOID POSSIBLE EXPOSURE TO EXCESSIVE MICROWAVE ENERGY" found on page 6.
- This appliance must be grounded. Connect only to properly grounded outlet. See "GROUNDING INSTRUCTIONS" found on page 10.
- Install or locate this appliance only in accordance with the provided Installation Instructions found on page 9.
- Some products such as whole eggs in the shell and sealed containers – for example, closed glass jars – could explode and should not be heated in this oven.
- Do not heat, store, or use flammable materials in or near the oven. Fumes could create a fire hazard or explosion.
- Use this appliance only for its intended use as described in this manual. Do not use corrosive chemicals or vapors in this appliance. This type of oven is specifically designed to heat or cook food. It is not designed for industrial or laboratory use.
- As with any appliance, close supervision is necessary when used by children.
- Do not operate this appliance if it has a damaged cord or plug, if it is not working properly, or if it has been damaged or dropped. Electrical shock, fire, or other hazards could result.
- Be careful when removing food after using the grill element. Element will still be hot and could cause burns.
- When grilling/crisping, do not use plastic utensils on the CRISPWARE™ Crisper Pan or grilling rack. The utensils could melt.
- This appliance should be serviced only by qualified service personnel. Call an authorized Whirlpool service company for examination, repair, or adjustment.
- Do not cover or block any opening on the appliance. Fire could result.
- Do not store or use this appliance outdoors. Do not use this product near water – for example, near a kitchen sink, in a wet basement, or near a swimming pool, and the like.
- Do not immerse cord or plug in water.
- Keep cord away from heated surfaces.
- Do not let cord hang over edge of table or counter.
- See door surface and interior cleaning instructions on page 55.

- To reduce the risk of fire in the oven cavity:
 - Do not overcook food. Carefully attend appliance if paper, plastic, or other combustible materials are placed inside the oven to facilitate microwave cooking. Paper could char or burn, and some plastics could melt if used when heating foods. Do not use any combustible materials when using the CRISPPWARE™ Crisper Pan or the grill feature.
 - Do not deep fry in oven. Microwavable utensils are not suitable and it is difficult to maintain appropriate deep frying temperatures.

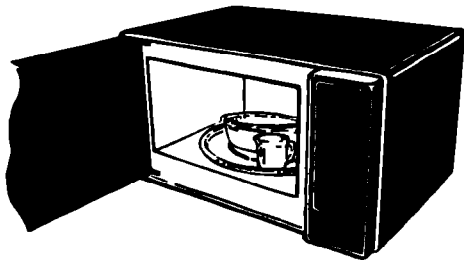

- **Test dinnerware or cookware before using.** To test a dish for safe use, put it into the oven with a cup of water beside it. Cook at 100% cook power for one minute. **If the dish gets hot and water stays cool, do not use it.** Some dishes (melamine, some ceramic dinnerware, etc.) absorb microwave energy, becoming too hot to handle and slowing cooking times. Cooking in metal containers not designed for microwave use could

- damage the oven, as could containers with hidden metal (twist-ties, foil lining, staples, metallic glaze or trim).
- Remove wire twist-ties from paper or plastic bags before placing bag in oven.

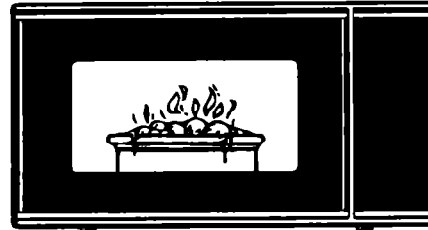

- If materials inside the oven should ignite, keep oven door closed, turn oven off, and disconnect the power cord or shut off power at the fuse or circuit breaker panel.

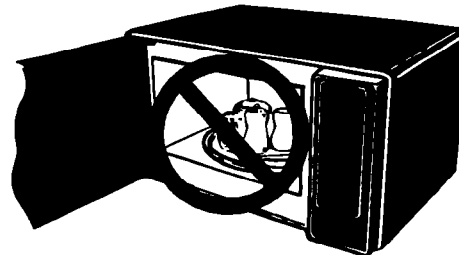

- Do not use the cavity for storage purposes. Do not leave anything in the cavity when not in use.
- Do not mount over a sink.
- Do not store anything directly on top of the appliance when appliance is in operation.

MICROWAVE OVEN SAFETY

- Read and follow "Operating safety precautions" starting on page 7.

1. A short power-supply cord is provided to reduce the risks resulting from becoming entangled in or tripping over a longer cord.
2. Longer cord sets or extension cords are available and may be used if care is exercised in their use.
3. If a long cord or extension cord is used temporarily, (a) the marked electrical rating of the cord set or extension cord should be at least as great as the electrical rating of the

appliance, (b) the extension cord must be a grounding-type, 3-wire cord that has a 3-blade grounding plug and a 3-slot receptacle that will accept the plug on the appliance, and (c) the longer cord should be arranged so that it will not drape over the countertop or tabletop where it can be pulled on by children or tripped over accidentally.

4. A qualified electrician must install a properly grounded and polarized 3-prong receptacle near the appliance.

– SAVE THESE INSTRUCTIONS –

PRECAUTIONS TO AVOID POSSIBLE EXPOSURE TO EXCESSIVE MICROWAVE ENERGY...

Do not attempt to operate this oven with the door open since open-door operation can result in harmful exposure to microwave energy. It is important not to defeat or tamper with the safety interlocks.

Do not place any object between the oven front face and the door or allow soil or cleaner residue to accumulate on sealing surfaces.

Do not operate the oven if it is damaged. It is particularly important that the oven door close properly and that there is no damage to the:

- (1) Door (bent),
- (2) Hinges and latches (broken or loosened),
- (3) Door seals and sealing surfaces.

Do not operate the microwave oven if the door window is broken.

The microwave oven should be checked for microwave leakage by qualified service personnel after a repair is made.

The oven should not be adjusted or repaired by anyone except properly qualified service personnel.

Do not operate the microwave oven with the outer cabinet removed.

Operating safety precautions

⚠ WARNING

To reduce the risk of fire, electrical shock, burns, injury to persons, or damage when using the microwave oven, follow the precautions on pages 7-8.

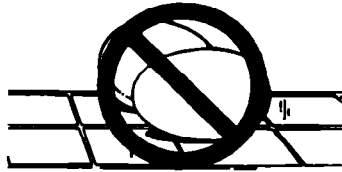

Never cook or reheat a whole egg inside the shell. Steam buildup in whole eggs may cause them to burst and burn you, and possibly damage the oven. **Slice** hard-boiled eggs before heating. In rare instances, poached eggs have been known to explode. **Cover** poached eggs and **allow** a standing time of one minute before cutting into them.



Stir before heating

For best results, stir thick liquids several times before heating or reheating. Liquids heated in certain containers (especially cylindrical containers) may become overheated. The liquid may splash out with a loud noise during or after heating or when adding ingredients (coffee, etc.) resulting in harm to the oven and possible personal injury.



Never lean on the door or allow a child to swing on it when the door is open. Injury could result.

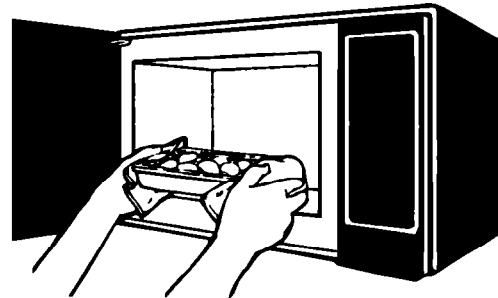

Use hot pads. Microwave energy does not heat containers, but hot food and the grill element do.

NOTE: Heat from the grill will cause container and oven parts to become hot. Also, the Crisper Pan always becomes very hot when used. Use oven mitts when touching containers, oven parts, and pan after grilling to prevent burns.

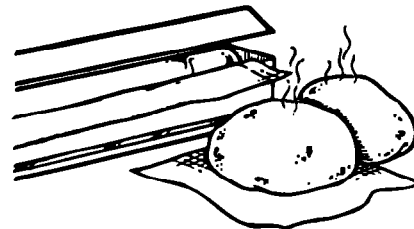

Do not overcook potatoes. Fire could result. At the end of the recommended cooking time, potatoes should be slightly firm because they will continue cooking during standing time. **After microwaving, wrap potatoes in foil and set aside for 5 minutes.** They will finish cooking while standing.

MICROWAVE OVEN SAFETY

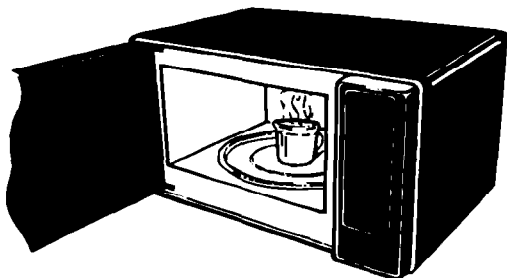

Do not start a microwave oven when it is empty. Product life may be shortened. If you practice programming the oven, put a container of water in the oven. It is normal for the oven door to look wavy after the oven has been running for a while.

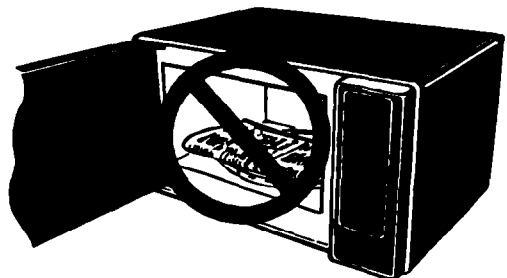

Do not use newspaper or other printed paper in the oven. Fire could result. **Do not** dry flowers, fruit, herbs, wood, paper, gourds, or clothes in the oven. Fire could result.

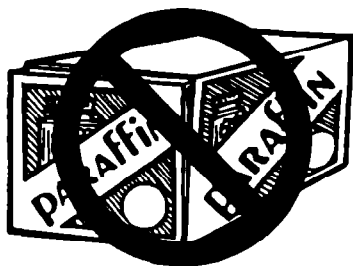

Do not try to melt paraffin wax in the oven. Paraffin wax will not melt in a microwave oven because it allows microwaves to pass through it.

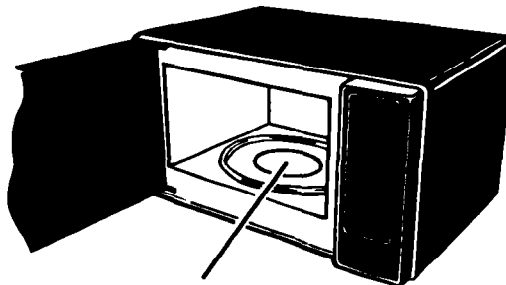

Glass turntable

Do not operate in the microwave mode unless the glass turntable is securely in place and can rotate freely. The turntable can rotate in either direction.

Make sure support base is all the way on the shaft in oven cavity floor. **Make sure** support rollers are completely inside center circle of turntable for proper rotation.

Make sure the glass turntable is correct-side up in oven. **Carefully place** cookware on glass turntable to avoid possible breakage.

Handle glass turntable with care when removing from oven to avoid possible breakage. If glass turntable cracks or breaks, contact your Whirlpool dealer for a replacement.

General information

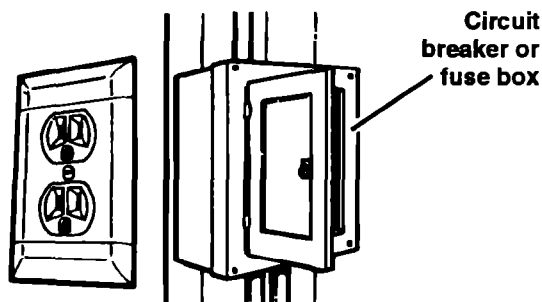

If your electric power line or outlet voltage is less than 110 volts, cooking times may be longer. Have a qualified electrician check your electrical system.

Installation Instructions

Before you begin operating the oven, carefully read the following instructions.

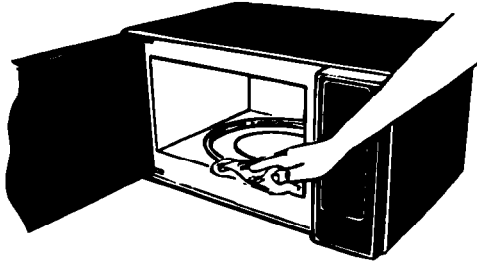

1. **Empty** the microwave oven and **clean** inside it with a soft, damp cloth. **Check** for damage such as misaligned door, damage around the door, or dents inside the oven or on the exterior. If there is any damage, do not operate the unit until it has been checked by an authorized Whirlpool service technician and any repairs made.

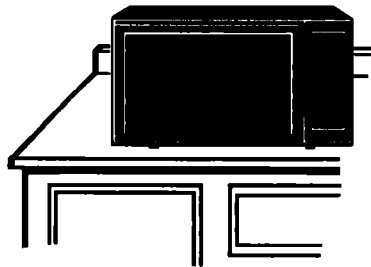

2. **Put** the oven on a cart, counter, table, or shelf that is strong enough to hold the oven and the food and utensils you put in it. **(The control side of the microwave oven is the heavy side. Use care when handling.)** The weight of the microwave oven is approximately 50 lbs (22.5 kg). The microwave oven should be at a temperature above 50°F (10°C) for proper operation.

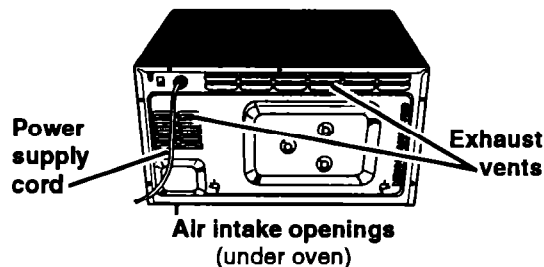

NOTE: Do not block the bottom air intake openings or rear exhaust vents. Allow a few

inches of space at back of oven where intake opening and exhaust vents are located. Blocking the air intake openings and exhaust vents could cause damage to the oven and poor cooking results. Make sure the microwave oven legs are in place to ensure proper airflow.

⚠WARNING

Excessive Exposure To Microwave Energy Hazard

Do not install the oven next to or over a heat source (for example, a cooktop or range) without a UL approved trim kit or without being in a UL approved built-in configuration. Also, do not install oven in any area where excessive heat and steam are generated. This could cause excessive exposure to microwave energy, fire, electrical shock, other personal injury, or damage to the outside of the cabinet.

Built-in kits

You can build your microwave oven into a wall or cabinet by using one of the kits listed on page 18.

These kits are available from your Whirlpool Dealer. If your dealer does not stock the kit, it can be ordered, by part number, by writing to:

Whirlpool Corporation
Attention: Customer Service Dept.
1900 Whirlpool Drive
LaPorte, IN 46350

OR by returning the customer order card enclosed with your Use and Care Guide.

3. Electrical requirements

Observe all governing codes and ordinances. A 120 Volt, 60 Hz, AC only, 15 or 20 amp fused electrical supply is required.

(Time-delay fuse is recommended.) It is recommended that a separate circuit serving only this appliance be provided.

4. GROUNDING INSTRUCTIONS

⚠ WARNING

Electrical Shock Hazard

Improper use of the grounding plug could result in a risk of electrical shock. **DO NOT, UNDER ANY CIRCUMSTANCES, REMOVE THE POWER SUPPLY CORD GROUNDING PRONG.**

5. For your personal safety, this appliance must be grounded. In the event of an electrical short circuit, grounding reduces the risk of electrical shock by providing an escape wire for the electric current. This appliance is equipped with a polarized 3-prong grounding plug. It must be plugged into a correctly polarized mating 3-prong grounding type wall receptacle, properly installed and grounded in accordance with the National Electrical Code and local codes and ordinances. If a mating wall receptacle is not available or if you are not sure if the wall receptacle is properly grounded and polarized, have it checked by a qualified electrician.

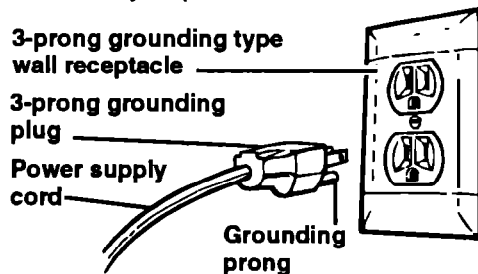

It is the personal responsibility and obligation of the customer to have a properly grounded and correctly polarized 3-prong wall receptacle installed by a qualified electrician.

Consult a qualified electrician if the grounding instructions are not completely understood, or if doubt exists as to whether the appliance is properly grounded.

It is not recommended to use an extension cord with your microwave oven, but if you find it necessary to do so temporarily (until a properly grounded and polarized 3-prong receptacle is installed), use only a heavy duty UL listed 3-wire grounding type extension cord containing three 16-gauge (minimum) copper wires. It must not be longer than 10 feet (cords longer than 10 feet may affect the cooking performance of your microwave oven). The plug on the extension cord must fit into a 3-prong grounding type wall receptacle (as shown on this page), and the receptacle end of the extension cord must accept the 3-prong grounding plug of the microwave oven.

6.  To test the oven, plug it into the proper electrical outlet. Put about one cup (250mL) of cold water in a glass container in the oven. Close the door. Make sure it latches. Follow the directions on page 28 to set the oven to cook for 2 minutes. When the time is up, the water should be heated.

7. **This microwave oven is designed for use in the household only and must not be used for commercial purposes.** Do not remove the door, control panel, or cabinet at any time. The unit is equipped with high voltage and should be serviced by an authorized Whirlpool service technician.

- SAVE THESE INSTRUCTIONS -

Getting to Know Your Microwave Oven

This section discusses the concepts behind microwave cooking and introduces you to the basics you need to know to operate your microwave oven. Please read this information before use.

How your microwave oven works

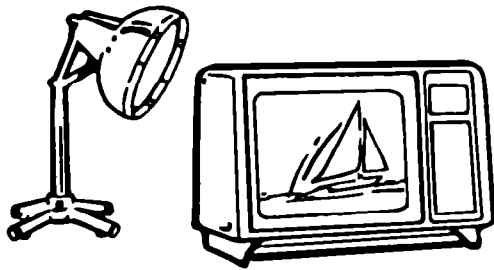

Microwave ovens are safe. Microwave energy is not hot. It causes food to make its own heat, and it's this heat that cooks the food.

Microwaves are like TV waves or light waves. You cannot see them, but you can see what they do.

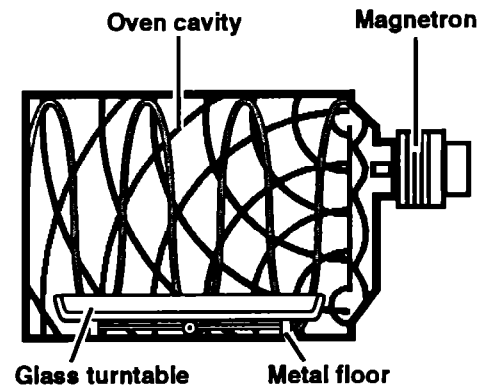

A magnetron in the microwave oven produces microwaves. The microwaves move into the oven where they contact food as it turns on the glass turntable.

Your microwave oven has the Whirlpool patented Double Emission System, which releases microwaves from two locations (one above food and one at bottom of food). Because the microwaves enter the oven at two different times, a third wave of microwaves is created. This gives you uniform cooking.

The glass turntable of your microwave oven lets microwaves pass through. Then they bounce off a metal floor, back through the glass turntable, and are absorbed by the food.

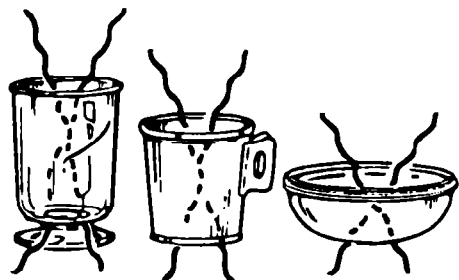

Microwaves pass through most glass, paper, and plastics without heating them so food absorbs the energy. Microwaves bounce off metal pans so food does not absorb the energy.

Microwaves do heat the CRISPWARE™ Crisper Pan, however. The rubberized pad on the bottom of the Crisper Pan is made of a special material which absorbs microwaves. This heats the pan very rapidly, browning and crisping the bottom of the food.

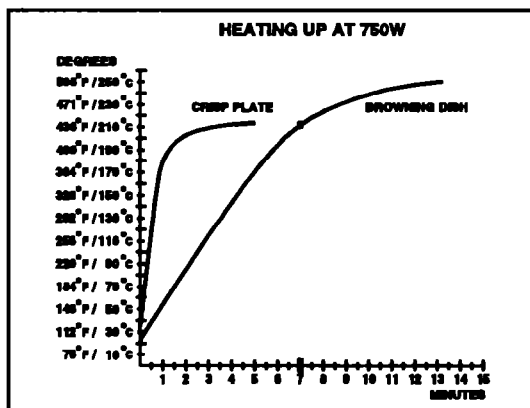

The Crisper Pan reaches 436°F (210°C) in about 2 minutes (faster than a browning dish) and stays at that temperature. The bottom coating of the Crisper Pan is designed to stop absorbing microwaves at 436°F (210°C), which is the best temperature for frying.

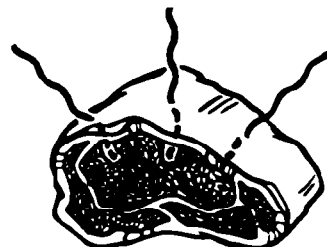

In most microwave ovens, microwaves may not reach the center of a roast. The heat spreads to the center from the outer, cooked areas just as in regular oven cooking. This is one of the reasons for letting some foods (for example, roasts or baked potatoes) stand for a while after cooking, or for stirring some foods during the cooking time.

The microwaves disturb water molecules in the food. As the molecules bounce around bumping into each other, heat is made, like rubbing your hands together. This is the heat that does the cooking.

Although your VIP CRISPWARE™ microwave oven cooks this way also, the Double Emission System allows microwaves to reach the center of the food more easily. This results in faster cooking.

Radio interference

Operation of the microwave oven may cause interference to your radio, TV, or similar equipment. When there is interference, it may be reduced or eliminated by taking the following measures:

- **Clean** door and sealing surfaces of the oven.
- **Adjust** the receiving antenna of radio or television.
- **Move** the receiver away from the microwave oven.
- **Plug** the microwave oven into a different outlet so that the microwave oven and receiver are on different branch circuits.

Microwave oven features

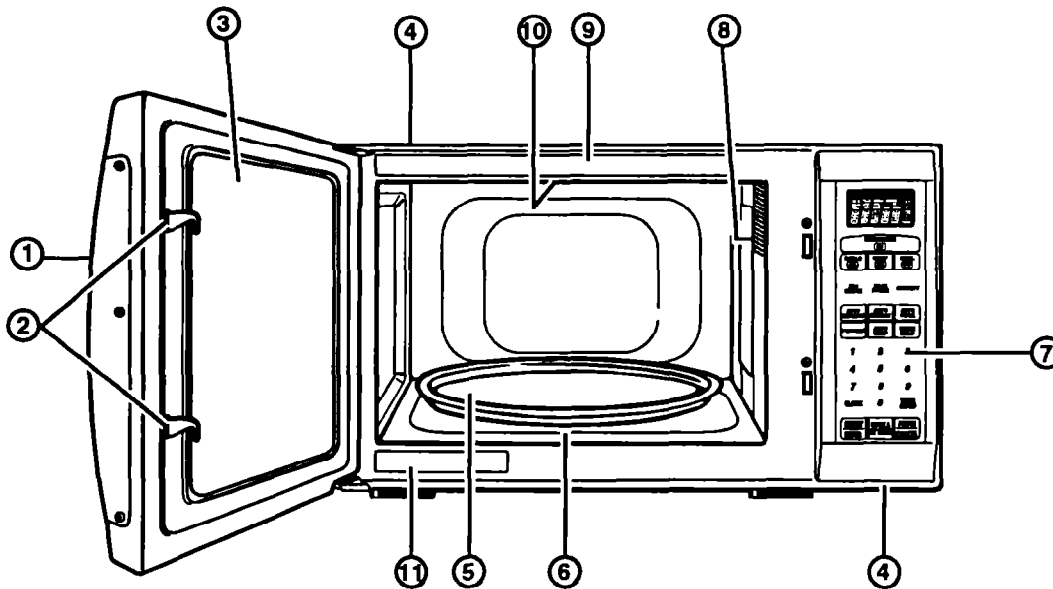

Your microwave oven is designed to make your cooking experience as enjoyable and productive as possible. To help get you up and running quickly, the following is a list of the oven's basic features:

1. **Door Handle.**
2. **Door Safety Lock System.** The oven will not operate unless the door is securely closed.
3. **Window with Metal Shield.** Shield prevents microwaves from escaping. It is designed as a screen to allow you to view food as it cooks.
4. **External Oven Air Vents** (on bottom and in back).
5. **Glass Turntable.** This turntable turns food as it cooks for more even cooking. It must be in the oven during operation for best cooking results. See pages 8, 11, and 55 for more details.
6. **Removable Turntable Support** (under turntable).
7. **Control Panel.** Touch pads on this panel to perform all functions. See pages 14 and 15 for more information.
8. **Light.** Automatically turns on when door is opened or when oven is operating.
9. **Cook Guide Label.**
10. **Quartz Grill Element** (hidden in ceiling). This element is used for the CRISP, AUTO CRISP, and GRILL functions. It is in a special computer-designed compartment that helps focus heat from the element onto the food. The quartz grill element is better than traditional grill elements because it gets hotter faster. And it is not in your way when you are cleaning the oven. See pages 47-54 for more information.
11. **Model and Serial Number Plate.**

NOTE: For information on the utensils that come with your microwave oven, see "Utensils" on page 17.

Control panel features

Your microwave oven control panel lets you select the desired cooking function quickly and easily. All you have to do is touch the necessary Command Pad. The following is a list of all the Command and Number Pads located on the control panel. For more information, see pages 18-54.

1. **Display.** This display includes indicators to tell you cooking time settings, quantities, weights, and cooking functions selected.
2. **MICROWAVE.** Touch this pad before entering a cooking time when setting a second or third cycle in multi-cycle cooking (see page 32) or when combination cooking with the grill element and microwaves (see page 54).
3. **SIZZLE.** Touch this pad to fry food with microwaves and your CRISPSWARE™ Crisper Pan. See page 45 for more information.
4. **CRISP.** Touch this pad to brown or crisp precooked pizza and other dough-based foods. Use it also for baking and to fry bacon and eggs, sausages, etc. See page 48 for more information.
5. **GRILL.** Touch this pad to prepare hamburgers, sausages, steaks, and cutlets. See page 52 for more information.
6. **ADD MINUTE.** Touch this pad to cook for one minute at 100% cook power or to add an extra minute to your cooking cycle. See page 24 for more information.
7. **COOK POWER.** Touch this pad to set the amount of microwave energy released to cook the food. The higher the number, the higher the microwave power or “cooking speed.” See page 29 for more information. See the “Microwave cooking chart” on page 58 for specific cook powers to use for the foods you are cooking.
8. **QUANTITY.** Touch this pad to set quantity, weight, or size for the food category you have selected in AUTO COOK, AUTO DEFROST, AUTO REHEAT, or AUTO CRISP. See pages 34, 38, 41, or 51 for more information.

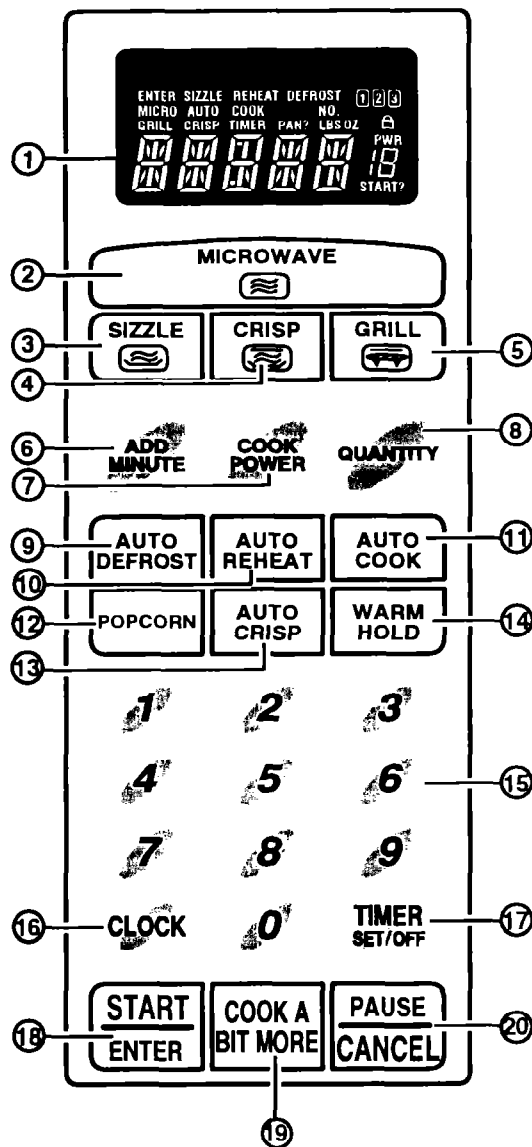

9. **AUTO DEFROST.** Touch this pad to thaw frozen food by weight. See page 37 for more information.
10. **AUTO REHEAT.** Touch this pad to reheat food in any one of six food categories, without entering cooking time or cook power. See page 41 for more information.
11. **AUTO COOK.** Touch this pad to cook common microwave-prepared foods without entering cooking time or cook power. See page 34 for more information.
12. **POPCORN.** Touch this pad to pop popcorn in your microwave oven. The oven will automatically heat for a preset time at a preset cook power. See page 43 for more information. Also use this pad to set Personal Choice. See page 25.
13. **AUTO CRISP.** Touch this pad to heat frozen or fresh foods that are normally oven baked, such as pizza. Choose from one of four preset food categories. See page 50 for more information.
14. **WARM HOLD.** Touch this pad to keep hot, cooked food safely warm in your microwave oven for up to 10 minutes. WARM HOLD can be used by itself, or it can automatically follow a cooking cycle. See page 44 for more information.
15. **Number Pads.** Touch Number Pads to enter cooking times.
The following Number Pads also have other functions:
 - **Number Pad 3** sets the Child Lock (see page 16).
 - **Number Pad 7** decreases cooking times (see page 20).
 - **Number Pad 9** increases cooking times (see page 20).
 - **Number Pad 8** returns a changed cooking time to the preset cooking time (see page 20).
16. **CLOCK.** Touch this pad to enter the correct time of day. See page 18 for more information.
17. **TIMER SET/OFF.** Touch this pad to set the Minute Timer. See page 19 for more information.
18. **START/ENTER.** Touch this pad to start a function that you have set. If you open the door after the oven begins to cook, retouch START/ENTER.
19. **COOK A BIT MORE.** Touch this pad after cooking stops to cook for a few more seconds. See page 24 for more information.
20. **PAUSE/CANCEL.** Touch this pad once to stop cooking briefly (see page 25) or to erase an incorrect command. Touch it twice to cancel a program during cooking or to clear the Display.

NOTES:

- **If you touch** two Command Pads for the same cycle (for example, AUTO DEFROST and AUTO COOK), the second command will cancel the first.
- **If you attempt** to enter unacceptable instructions, "RETRY" will appear on the Display and three tones will sound.

Audible signals

Audible signals are available to guide you when setting and using your oven:

- **A programming tone will sound** each time you touch a pad.
- **Four tones** signal the end of a cooking cycle.
- **One tone** signals the end of the Minute Timer countdown.

To cancel tones, follow this chart:

| HOLD DOWN NUMBER PAD | CANCELS |
|----------------------|------------------------------------|
| 1 | Programming tone |
| 2 | All tones except end-of-timer tone |

Hold down the Number Pad until you hear two shorts tones (about four seconds). Repeat to turn back on.

Interrupting cooking

You can stop the oven during a cycle by opening the door. The oven stops heating and the fan stops, but the light stays on.

To restart cooking, close the door and

Touch



If you do not want to continue cooking:

- **Close** the door and the light goes off.

OR

- **Touch**



Using the child lock

The Child Lock prevents small children from using the microwave oven when you don't want them to.

To lock the control panel:

Touch and hold Number Pad 3 for 4 seconds.  will appear on the Display. If any pad is touched, "LOCK" will appear on the Display.

To unlock the control panel:

Touch and hold Number Pad 3 again for 4 seconds.



Utensils

Your microwave oven comes with two useful cooking utensils. Please review this chart to become familiar with their use.

⚠ WARNING

Burn Hazard

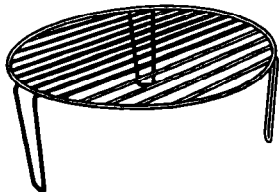
- Use oven mitts when removing grilling rack and CRISPWARE™ Crisper Pan.
 - Use Crisper Pan handle when removing Crisper Pan.
- Failure to follow these instructions could result in burns.

| UTENSIL | HOW TO USE IT |
|---|--|
| <p>Grilling Rack</p>  | <p>Use for faster browning of small amounts of food. Place rack securely on turntable. Using rack will put food close to the grill element.</p> |
| <p>CRISPWARE Crisper Pan</p>  <p>Crisper Pan Handle</p>  | <p>Use to give foods such as pizza and pies a nice crisp, brown bottom surface. Do not place any other utensils on the Crisper Pan since the pan quickly becomes very hot and can cause damage to the utensil. Always use the turntable as support for the Crisper Pan.</p> <p>The Crisper Pan is designed specifically for use with the patented Double Emission System in this oven. Do not use Crisper Pan in any other microwave oven or in a thermal oven.</p> <p>The Crisper Pan is dishwasher-safe.</p> <p>NOTE: Only use wooden or plastic cooking utensils on the Crisper Pan to prevent scratches.</p> |

Pan order chart

12¹/₄" x 1" Crisper Pan P.N. 4378130
 11¹/₂" x 1" Crisper Pan P.N. 4378131
 11" x 1³/₈" Baking Pan P.N. 4378132

To order additional Crisper or Baking Pans, see chart above and write to:

Whirlpool Corporation
 Attention: Customer Service Dept.
 1900 Whirlpool Drive
 LaPorte, IN 46350

OR Use the CRISPWARE order card included with your Use and Care Guide.

Built-in kits

You can build in your microwave oven by using one of the following trim kits:

| SIZE | COLOR | KIT MODEL NO. | KIT PART NO. |
|------|-------|---------------|--------------|
| 30" | White | MK8120XBQ | 4378491 |
| 30" | Black | MK8120XBB | 4378492 |
| 27" | White | MK8127XBQ | 4378494 |
| 27" | Black | MK8127XBB | 4378495 |
| 24" | White | MK8124XBQ | 4378497 |
| 24" | Black | MK8124XBB | 4378498 |

All built-in kits are for installation over Whirlpool electric ovens that have model numbers starting with "RB". See page 9 for more information.

Setting the clock

When your microwave oven is first plugged in or after a power failure, the clock will start keeping time at 12:00.

NOTES:

- **You can only set** the clock if the oven is not cooking food or timing with the Minute Timer.
- **If you touch** PAUSE/CANCEL while setting the clock, the clock will be cleared and the Display will show ":".

To set time:

1. Choose the clock.

TOUCH



YOU SEE



2. Enter time of day.

Example for 5:30:

TOUCH



YOU SEE



3. Complete entry.

TOUCH



YOU SEE



Using the Minute Timer

NOTE: You can use other Command Pads while the Minute Timer is counting down.

1. Choose the Timer.

TOUCH



YOU SEE



2. Enter time to be counted down.

Example for 10 minutes:

TOUCH

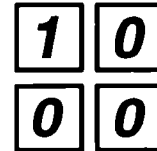

YOU SEE



3. Start countdown.

TOUCH



YOU SEE



(display shows time counting down)

At end of countdown:
A tone will sound.

YOU SEE

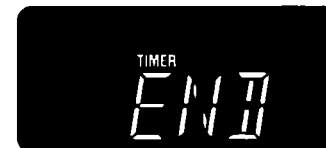

Changing cooking times

To change cooking times during cooking:

(high cook power cooking, lower cook power cooking, sizzle setting, crisp setting, grill setting)

If you want to change nonautomatic cooking times while the oven is cooking, just press Number Pads for the time you want and the new cooking time will start counting down in 5 seconds.

To change cooking times before cooking starts:

(AUTO COOK, AUTO REHEAT, AUTO CRISP)

You can change the preset cooking time for AUTO COOK, AUTO REHEAT, and AUTO CRISP in the following way:

- **To decrease cooking time**, touch Number Pad 7 once for LESS 1, twice for LESS 2, and three times for LESS 3.
- **To increase cooking time**, touch Number Pad 9 once for MORE 1, twice for MORE 2, and three times for MORE 3.
- **To return to the preset time**, touch Number Pad 8. "NORML" will appear on the Display.

Changing preset cooking times

This chart shows you the cooking times you can get for each auto function when using Number Pads 7 and 9.

NOTE: You cannot change cooking times for AUTO DEFROST.

| AUTO CYCLE | FOOD | QUANTITY | PRESET TIME | LESS 1 | LESS 2 | LESS 3 | MORE 1 | MORE 2 | MORE 3 |
|------------|---------------|----------|-------------|--------|--------|--------|--------|--------|--------|
| AUTO COOK | Frozen Dinner | 9 oz | 5:40 | 4:57 | 4:15 | 3:32 | 6:22 | 7:05 | 7:47 |
| | | 11 oz | 6:40 | 5:50 | 5:00 | 4:10 | 7:30 | 8:20 | 9:10 |
| | | 16 oz | 9:00 | 7:52 | 6:45 | 5:37 | 10:07 | 11:15 | 12:22 |
| | Casseroles | 2 cups | 3:20 | 2:55 | 2:30 | 2:05 | 3:45 | 4:10 | 4:35 |
| | | 4 cups | 6:00 | 5:15 | 4:30 | 3:45 | 6:45 | 7:30 | 8:15 |
| | | 6 cups | 8:50 | 7:43 | 6:37 | 5:31 | 9:56 | 11:02 | 12:08 |

GETTING TO KNOW YOUR MICROWAVE OVEN

| AUTO CYCLE | FOOD | QUANTITY | PRESET TIME | LESS 1 | LESS 2 | LESS 3 | MORE 1 | MORE 2 | MORE 3 |
|---------------------------------|--------------------------|----------|-------------|--------|--------|--------|--------|--------|--------|
| AUTO COOK (continued) | Frozen Vegetables | 1 cup | 3:20 | 2:30 | 1:40 | :50 | 4:10 | 5:00 | 5:50 |
| | | 2 cups | 5:40 | 4:15 | 2:50 | 1:25 | 7:05 | 8:30 | 9:55 |
| | | 3 cups | 8:40 | 6:30 | 4:20 | 2:10 | 10:50 | 13:00 | 15:10 |
| | | 4 cups | 10:50 | 8:07 | 5:25 | 2:42 | 13:32 | 16:15 | 18:57 |
| | Canned Vegetables | 1 cup | 2:00 | 1:45 | 1:30 | 1:15 | 2:15 | 2:30 | 2:45 |
| | | 2 cups | 3:50 | 3:20 | 2:52 | 2:23 | 4:18 | 4:47 | 5:15 |
| | | 3 cups | 5:30 | 4:48 | 4:07 | 3:26 | 6:11 | 6:52 | 7:33 |
| | | 4 cups | 7:30 | 6:33 | 5:37 | 4:41 | 8:26 | 9:22 | 10:18 |
| | Fresh Vegetables | 1 cup | 3:50 | 2:52 | 1:55 | :57 | 4:47 | 5:45 | 6:42 |
| | | 2 cups | 5:20 | 4:00 | 2:40 | 1:20 | 6:40 | 8:00 | 9:20 |
| | | 3 cups | 6:30 | 4:52 | 3:15 | 1:37 | 8:07 | 9:45 | 11:22 |
| | | 4 cups | 8:00 | 6:00 | 4:00 | 2:00 | 10:00 | 12:00 | 14:00 |
| | Popcorn | 1.75 oz | 2:10 | 2:01 | 1:53 | 1:45 | 2:18 | 2:26 | 2:34 |
| | | 3.5 oz | 2:40 | 2:30 | 2:20 | 2:10 | 2:50 | 3:00 | 3:10 |
| | Baked Potatoes | 1 | 4:00 | 3:00 | 2:00 | 1:00 | 5:00 | 6:00 | 7:00 |
| | | 2 | 6:50 | 5:02 | 3:25 | 1:42 | 8:32 | 10:15 | 11:57 |
| | | 3 | 9:30 | 7:07 | 4:45 | 2:22 | 11:52 | 14:15 | 16:37 |
| | | 4 | 12:30 | 9:22 | 6:15 | 3:07 | 15:37 | 18:45 | 21:52 |
| | | 5 | 15:00 | 11:15 | 7:30 | 3:45 | 18:45 | 22:30 | 26:15 |
| | | 6 | 17:30 | 13:07 | 8:45 | 4:22 | 21:52 | 26:15 | 30:37 |
| AUTO REHEAT | Dinner Plate | 1 plate | 3:25 | 2:10 | 1:52 | 1:33 | 2:48 | 3:07 | 3:25 |
| | | 2 plates | 6:10 | 3:55 | 3:22 | 2:48 | 5:03 | 5:37 | 6:10 |
| | Bread | 1 slice | :15 | :10 | :7 | :3 | :18 | :22 | :25 |
| | | 2 slices | :25 | :18 | :12 | :6 | :31 | :37 | :43 |

GETTING TO KNOW YOUR MICROWAVE OVEN

| AUTO CYCLE | FOOD | QUANTITY | PRESET TIME | LESS 1 | LESS 2 | LESS 3 | MORE 1 | MORE 2 | MORE 3 |
|----------------------------|------------|------------|-------------|--------|--------|--------|--------|--------|--------|
| AUTO REHEAT (continued) | | 3 slices | :35 | :25 | :17 | :8 | :43 | :52 | 1:00 |
| | | 4 slices | :45 | :33 | :22 | :11 | :56 | 1:07 | 1:18 |
| | | 5 slices | :55 | :40 | :27 | :13 | 1:08 | 1:22 | 1:35 |
| | | 6 slices | 1:05 | :48 | :32 | :16 | 1:21 | 1:37 | 1:53 |
| | Meats | 1 serving | 1:00 | :45 | :30 | :15 | 1:15 | 1:30 | 1:45 |
| | | 2 servings | 1:40 | 1:15 | :50 | :25 | 2:05 | 2:30 | 2:55 |
| | | 3 servings | 2:20 | 1:45 | 1:10 | :35 | 2:55 | 3:30 | 4:05 |
| | | 4 servings | 3:00 | 2:15 | 1:30 | :45 | 3:45 | 4:30 | 5:15 |
| | | 5 servings | 3:40 | 2:45 | 1:50 | :55 | 4:35 | 5:30 | 6:25 |
| | | 6 servings | 4:20 | 3:15 | 2:10 | 1:05 | 5:25 | 6:30 | 7:35 |
| | Vegetables | 1 cup | :50 | :37 | :25 | :12 | 1:02 | 1:15 | 1:27 |
| | | 2 cups | 1:35 | 1:10 | :47 | :23 | 1:58 | 2:22 | 2:45 |
| | | 3 cups | 2:20 | 1:45 | 1:10 | :35 | 2:55 | 3:30 | 4:05 |
| | | 4 cups | 3:00 | 2:15 | 1:30 | :45 | 3:45 | 4:30 | 5:15 |
| | Soups | 1 cup | 1:55 | 1:25 | :57 | :28 | 2:23 | 2:52 | 3:20 |
| | | 2 cups | 3:50 | 2:52 | 1:55 | :57 | 4:47 | 5:45 | 6:42 |
| | | 3 cups | 5:45 | 4:18 | 2:52 | 1:26 | 7:11 | 8:37 | 10:03 |
| | | 4 cups | 7:40 | 5:45 | 3:50 | 1:55 | 9:35 | 11:30 | 13:25 |
| | Sauce | 1 cup | 1:40 | 1:15 | :50 | :25 | 2:05 | 2:30 | 2:55 |
| | | 2 cups | 3:20 | 2:30 | 1:40 | :50 | 4:10 | 5:00 | 5:50 |
| | | 3 cups | 5:00 | 3:45 | 2:30 | 1:15 | 6:15 | 7:30 | 8:45 |

GETTING TO KNOW YOUR MICROWAVE OVEN

| AUTO CYCLE | FOOD | QUANTITY | PRESET TIME | LESS 1 | LESS 2 | LESS 3 | MORE 1 | MORE 2 | MORE 3 |
|-------------------|------------------------|-----------------|--------------------|---------------|---------------|---------------|---------------|---------------|---------------|
| AUTO CRISP | Frozen Pizza | 8 in | 10:50 | 8:07 | 5:25 | 2:38 | 13:28 | 16:15 | 18:57 |
| | | 9 in | 11:40 | 8:45 | 5:50 | 2:55 | 14:35 | 17:26 | 20:21 |
| | | 10 in | 12:30 | 9:22 | 6:15 | 3:07 | 15:37 | 18:45 | 21:52 |
| | | 12 in | 15:40 | 11:37 | 7:45 | 3:52 | 19:22 | 23:15 | 27:07 |
| | Fresh Pizza | 8 in | 9:00 | 6:22 | 4:15 | 2:07 | 10:37 | 12:45 | 14:52 |
| | | 9 in | 10:00 | 7:05 | 4:44 | 2:21 | 11:51 | 14:14 | 66:35 |
| | | 10 in | 11:00 | 7:52 | 5:15 | 2:37 | 13:07 | 15:45 | 18:22 |
| | | 12 in | 13:00 | 9:45 | 6:30 | 3:15 | 16:15 | 19:30 | 22:45 |
| | Frozen Potatoes | .5 lb | 11:00 | 8:15 | 5:30 | 2:45 | 13:45 | 16:30 | 19:15 |
| | | 1 lb | 16:00 | 11:37 | 7:45 | 3:52 | 19:22 | 23:15 | 27:07 |
| | | 1.5 lbs | 19:40 | 14:44 | 9:50 | 4:54 | 24:34 | 29:33 | 34:24 |
| | Frozen Chicken | .5 lb | 11:00 | 7:52 | 5:15 | 2:37 | 13:07 | 15:45 | 18:22 |
| | | 1 lb | 17:10 | 12:52 | 8:35 | 4:17 | 21:27 | 25:45 | 30:02 |
| | | 1.5 lbs | 19:20 | 14:29 | 9:40 | 4:49 | 24:09 | 29:00 | 33:49 |

Using ADD MINUTE

ADD MINUTE lets you cook food for one minute at 100% Cook Power or add an extra minute to your cooking cycle. You can also use it to extend cooking time in multiples of one minute.

NOTES:

- To extend cooking time in multiples of one minute, touch ADD MINUTE repeatedly during cooking.
- You can enter ADD MINUTE only after closing the door.
- You cannot use ADD MINUTE with AUTO DEFROST, AUTO COOK, AUTO REHEAT, or AUTO CRISP.

1. Make sure food is in oven.

2. Choose setting.

Example for one minute:

TOUCH



once

YOU SEE

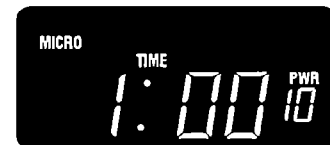

When cooking time ends:

YOU SEE



(four tones will sound)

Using COOK A BIT MORE

COOK A BIT MORE lets you cook for several more seconds after the set cooking time is over. Just touch COOK A BIT MORE while "END" is still on the Display and your microwave oven will cook a little longer.

NOTES:

- For **AUTO DEFROST**, COOK A BIT MORE will always cook at 20% Cook Power instead of the Cook Power preset for the setting just finished.
- For **CRISP**, COOK A BIT MORE will cook for thirty more seconds, plus one additional second for every eight seconds of the set cooking time.

Example for 48 seconds cooking time:

TOUCH



YOU SEE



Using PAUSE

PAUSE lets you pause during cooking.

1. Choose PAUSE.

Every 10 seconds the Display will show the set cooking time.

TOUCH



YOU SEE



2. Resume cooking.

TOUCH



YOU SEE



(example)

Using Personal Choice

By programming the Popcorn Pad, you can recall one cooking instruction previously placed in memory and begin cooking quickly. For example, if you heat a roll every morning, program the cooking steps into Personal Choice. You can heat your roll each morning by touching POPCORN. Personal Choice also lets you program a cooking time and cook power for another person to cook at a later time.

NOTES:

- **You can reprogram** Personal Choice by repeating the instructions below. A power failure will erase your Personal Choice program.
- **Setting** Personal Choice will erase the cooking time and cook power for popping popcorn. To pop popcorn, use Setting 6 in AUTO COOK (see pages 34-36).

To program Personal Choice:

1. Touch POPCORN and hold for four seconds.

TOUCH



Hold for 4 seconds

YOU SEE



2. Set cooking time.

Example for 20 seconds:

TOUCH



YOU SEE



GETTING TO KNOW YOUR MICROWAVE OVEN

3. Set Cook Power.

TOUCH



YOU SEE



Example for 50% Cook Power:

TOUCH



YOU SEE



5 times

OR



4. Complete entry.

TOUCH

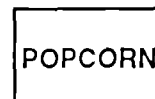

YOU SEE



(time of day)

To use Personal Choice:

1. Put food in oven and close door.

2. Choose Personal Choice.

The oven will cook according to your preprogrammed instructions.

TOUCH

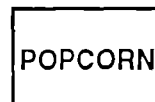

YOU SEE



(display counts down cooking time)

At end of cooking time:

YOU SEE



(four tones will sound)

3. After cooking, open the door OR TOUCH

YOU SEE



(time of day)

Cooking with Microwaves Only

This section gives you instructions for operating each microwave function. Please read these instructions carefully.

To get the best cooking results:

- **ALWAYS** cook food for the minimum recommended cooking time. If necessary, touch ADD MINUTE (see page 24) or Number Pads (see page 20) while the oven is operating. Also, you can add to the cooking time after cooking is over with COOK A BIT MORE (see page 24). Then check for doneness to avoid overcooking the food.
- **Stir thick liquids** being heated about halfway through the heating time for most even doneness with all recipes.
- **If a glass cover is not available, use wax paper, paper towels, or microwave-approved plastic wrap. Turn back** a corner to vent steam during cooking.
- **Although a new rating method*** rates this oven at 900 watts, you may use a reliable cookbook and recipes developed for microwave ovens previously rated at 700-800 watts.

* IEC-705 Test Procedure. The IEC-705 Test Procedure is an internationally recognized method of rating microwave wattage output and does not represent an actual change to output power or cooking performance.

Cooking at high cook power

1. Put food in oven and close door.

2. Set cooking time.

Example for one minute, 30 seconds:

TOUCH

1

3

0

YOU SEE



3. Start oven.

NOTES:

- If you want to add more time during cooking use ADD MINUTE. See page 24 for more information.
- If you want to add more time after cooking use COOK A BIT MORE. See page 24 for more information.

At end of cooking time:

TOUCH

START
ENTER

YOU SEE



(oven automatically cooks at high cook power/display counts down time)

YOU SEE



(four tones will sound)

4. After cooking, open the door OR TOUCH

PAUSE
CANCEL

YOU SEE



(time of day)

Cooking at lower cook powers

For best results, some recipes call for lower cook powers. The lower the cook power, the slower the cooking. Each Number Pad also stands for a different percentage of cook power. Many microwave cookbook recipes tell you by number, percent, or name which cook power to use.

The following chart gives the percentage of cook power each Number Pad stands for, and the cook power name usually used. It also tells you when to use each cook power. Follow recipe or food package instructions if available.

| COOK POWER | NAME | WHEN TO USE IT |
|------------------------------|---------------------|---|
| Automatic 100% of full power | High | <ul style="list-style-type: none"> • Quick heating many convenience foods and foods with high water content, such as soups and beverages • Cooking tender cuts of meat, ground meat, poultry pieces, fish fillets, and vegetables |
| 9=90% of full power | | <ul style="list-style-type: none"> • Heating cream soups |
| 8=80% of full power | | <ul style="list-style-type: none"> • Heating rice, pasta, or casseroles |
| 7=70% of full power | Medium-High | <ul style="list-style-type: none"> • Cooking and heating foods that need a cook power lower than high (for example, whole fish and meat loaf) or when food is cooking too fast • Reheating a single serving of food |
| 6=60% of full power | | <ul style="list-style-type: none"> • Cooking requiring special care, such as cheese and egg dishes, pudding, and custards • Finishing cooking casseroles |
| 5=50% of full power | Medium | <ul style="list-style-type: none"> • Cooking ham, whole poultry, and pot roasts • Melting chocolate |
| 4=40% of full power | | <ul style="list-style-type: none"> • Simmering stews • Heating pastries |
| 3=30% of full power | Medium-Low, Defrost | <ul style="list-style-type: none"> • Defrosting foods, such as bread, fish, meats, poultry, and precooked foods |
| 2=20% of full power | | <ul style="list-style-type: none"> • Softening butter, cheese, and ice cream |
| 1=10% of full power | Low | <ul style="list-style-type: none"> • Keeping food warm • Taking chill out of fruit |

continued on next page

1. Put food in oven and close door.

2. Set cooking time.

Example for ten minutes, 30 seconds:

TOUCH

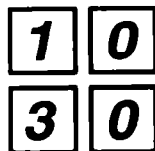

YOU SEE



3. Set cook power.

Example for 50% cook power:

Each time you touch COOK POWER, the cook power will decrease by ten percent.

TOUCH



6 times
OR



once
AND



YOU SEE



4. Start oven.

NOTES:

- If you want to add more time during cooking use ADD MINUTE. See page 24 for more information.
- If you want to add more time after cooking use COOK A BIT MORE. See page 24 for more information.

At end of cooking time:

TOUCH



YOU SEE



(display counts down time)

YOU SEE



(four tones will sound)

5. After cooking, open the door OR

TOUCH



YOU SEE



(time of day)

To change cook power after cooking has started:

Touch COOK POWER until the cook power you want is displayed or touch the correct Number Pad.

NOTE: You cannot change the cook power when oven is operating during AUTO DEFROST, AUTO COOK, AUTO REHEAT, AUTO CRISP, GRILL, CRISP, or SIZZLE.

TOUCH



1-10 times
OR



once
AND
A Number Pad

Cooking with more than one cook cycle

For best results, some recipes call for one cook power for a certain length of time, and another cook power for another length of time. Your oven can be set to change from one to another automatically.

1. Put food in oven and close door.

2. Set cooking time for first cycle.

Example for seven minutes, 30 seconds:

TOUCH



YOU SEE



3. Set cook power for first cycle (optional).

If you want to cook at full (100%) cook power, go to Step 4.

Example for 50% cook power:

TOUCH



6 times
OR



once
AND



YOU SEE

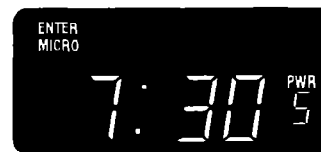

COOKING WITH MICROWAVES ONLY

4. Touch **MICROWAVE** to set second cycle.

TOUCH



YOU SEE

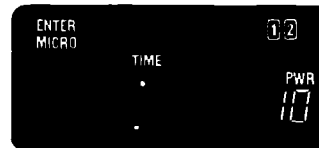

5. Set cooking time for second cycle.

Example for three minutes, 25 seconds:

TOUCH



YOU SEE



6. Set cook power for second cycle (optional).

If you want to cook at full (100%) cook power, go to Step 7.

Example for 60% cook power:

TOUCH



5 times
OR



once
AND



YOU SEE



7. Repeat Steps 4-6 above for third cycle (optional).

8. Start oven.

Two short tones will sound between cycles.

NOTES:

- If you want to add more time during cooking use ADD MINUTE. See page 24 for more information.
- If you want to add more time after cooking use COOK A BIT MORE. See page 24 for more information.

At end of cooking time:

TOUCH



YOU SEE



(display counts down cooking time in each cycle, starting with the first cycle)

YOU SEE



(four tones will sound)

9. After cooking, open the door OR TOUCH



YOU SEE



(time of day)

Using AUTO COOK

Cooking with AUTO COOK lets you cook common microwave-prepared foods without needing to set times and cook powers. AUTO COOK has preset times and cook powers for: Frozen Dinner, Casseroles, Frozen Vegetables, Canned Vegetables, Fresh Vegetables, Popcorn, and Baked Potatoes (see chart on page 36). All you do is touch the Auto Cook Pad until you reach

the desired category, or touch a Number Pad. Then you touch the Quantity Pad until you reach the desired quantity. Your microwave oven does the rest.

NOTE: See "Microwave cooking chart" on page 58 when cooking with cooking time and cook power.

1. Put food in oven and close door.

2. Choose setting.

TOUCH



YOU SEE



3. Choose food class.

Keep touching AUTO COOK until the food that you are cooking appears on the Display. Or you can touch the Number Pad that goes with the food setting you want.

Example for Casseroles (Setting 2):

TOUCH



twice

YOU SEE



NOTE: To choose the desired food setting, see the Cook Guide Label on the front frame of the oven or the "Auto cook chart" on page 36.

4. Enter number of items (or cups) to be heated.

Example for 2 cups:

TOUCH



once

YOU SEE



Touch START/ENTER or wait 5 seconds:

TOUCH



YOU SEE



(display counts down cooking time)

If you want to change cooking time, touch Number Pad 7 or 9 one to three times (see page 20 for more information).

NOTES:

- **Next time** you cook this type of food with AUTO COOK, the oven will automatically cook for the new time you have set. To change back to the original cooking time, touch Number Pad 8 after entering the quantity.
- **You can only change** cooking time before the countdown starts (immediately after you enter the quantity).

At end of cooking time:

TOUCH



three times
(example)

YOU SEE



(new cooking time)

YOU SEE



(four tones will sound)

5. After cooking, open the door OR

TOUCH



YOU SEE



(time of day)

Auto cook chart

| SETTING | FOOD | AMOUNT | PROCEDURE |
|---------|--------------------------|-----------------|---|
| 1 | Frozen Dinner | 9,11, or 16 oz | Follow package directions. |
| 2 | Casseroles | 2, 4, or 6 cups | To reheat, flatten on plate or place in bowl. Cover with vented plastic wrap. Stir before serving, if possible. |
| 3 | Frozen Vegetables | 1-4 cups | Place in a microwave-safe container. Cover with lid or plastic wrap. After cooking remove from oven, stir, cover, and let stand 3 minutes before serving. |
| 4 | Canned Vegetables | 1-4 cups | Place in a microwave-safe container. Cover with lid or plastic wrap. After cooking remove from oven, stir, cover, and let stand 3 minutes before serving. |
| 5 | Fresh Vegetables | 1-4 cups | Place in a microwave-safe container. For beans, carrots, corn, and peas, add 1 tablespoon water per cup. For broccoli, brussels sprouts, cabbage, and cauliflower, cook immediately after washing with no additional water. If you like tender-crisp vegetables, set the Auto Cook quantity for half the amount of vegetables you are actually cooking. For example, when cooking 2 cups of vegetables, set AUTO COOK for 1 cup. Cover with lid or plastic wrap. After cooking, remove from oven, stir, cover, and let stand 3 to 5 minutes before serving. |
| 6 | Popcorn | 1.75 or 3.5 oz | Place bag in center of turntable and close door. Pop only one package at a time. If you are using a microwave popcorn popper, follow manufacturer's instructions. Cooking performance may vary with brand. Try several brands to decide which gives best popping results. For best results, use fresh bags of popcorn. |
| 7 | Baked Potatoes | 1-6 | Prick; place on paper towel directly on turntable. After cooking, remove from oven and let stand wrapped in foil 5 minutes. NOTE: For large (8-10 ounce) potatoes, enter a quantity greater than the actual number of potatoes to be cooked. (Example: for one large potato, enter "4".) For small (4 ounce) potatoes, enter a quantity less than the actual number of potatoes to be cooked. (Example: for three small potatoes, enter "1" or "2".) Use COOK A BIT MORE to change cooking time. See page 24 for more information. |

NOTE: When cooking a 10 oz package of frozen vegetables (this equals about 1½ cups), touch "QUANTITY" once for 1 cup of "tender crisp" vegetables (you cannot enter ½ cup amounts) or touch "QUANTITY" twice for 2 cups of vegetables more fully cooked.

Using AUTO DEFROST

Your microwave oven automatically defrosts a variety of common foods at preset cook powers for preset times. AUTO DEFROST has preset times and cook powers for: Meat, Chicken, Fish, Vegetables, Fruit, and Bread (see chart on page 39). All you do is touch the Auto Defrost Pad until you reach the desired category, or touch a Number Pad. Then you touch the Quantity Pad until you reach the desired quantity. Your microwave oven does the rest.

NOTE: Standing time is included in AUTO DEFROST times. This may make defrost times seem longer than in other microwave ovens. (See page 40 for more information.)

1. Put frozen food in oven and close door.

2. Choose setting.

TOUCH



YOU SEE



3. Choose food setting.

Keep touching AUTO DEFROST until the food that you are defrosting appears on the Display. Or you can touch the Number Pad that goes with the food setting you want.

Example for Meats (Setting 1):

TOUCH



once

YOU SEE



NOTE: To choose the desired food setting, see the Cook Guide Label on the front frame of the oven or the "Auto defrost chart" on page 39.

4. Enter food's weight.

Example for .25 lb:

NOTES:

- See the "Weight conversion chart" on page 40 for help in converting food weight to decimals.
- See the "Auto defrost chart" on page 39 for weight ranges available for each food category.

Touch START/ENTER or wait 5 seconds:

At end of defrosting time:

TOUCH



once

OR



YOU SEE



TOUCH



YOU SEE



(display counts down defrosting time)

YOU SEE



(four tones will sound)

5. After defrosting, open the door OR TOUCH



YOU SEE



(time of day)

Auto defrost chart

| SETTING | FOOD | MINIMUM WEIGHT/QTY | MAXIMUM WEIGHT/QTY |
|---------|---|--------------------|------------------------|
| 1 | Meats • Pork Chops • Steaks • Roasts • Ground Meat | .10 lb (1 oz) | 6.60 lbs (6 lbs, 8 oz) |
| 2 | Chicken • Chicken, Whole or In Pieces • Turkey • Cornish Hens • Whole Duckling | .10 lb (1 oz) | 6.60 lbs (6 lbs, 8 oz) |
| 3 | Fish • Steaks • Fillets • Whole Fish • Lobster Tails • Shrimp, Scallops | .10 lb (1 oz) | 4.40 lbs (4 lbs, 6 oz) |
| 4 | Vegetables • Broccoli • Cauliflower • Mixed Vegetables • Other Frozen Vegetables | .10 lb (1 oz) | 4.40 lbs (4 lbs, 6 oz) |
| 5 | Fruit • Strawberries • Blueberries • Raspberries • Mixed Fruit | .10 lb (1 oz) | 4.40 lbs (4 lbs, 6 oz) |
| 6 | Bread • Loaf • Buns • Rolls • Muffins • Pastry | 1 | 4 |

NOTES:

- If you go past the maximum weight or quantity, "RETRY" appears on the Display and 3 tones will sound. AUTO DEFROST will only operate within the weight/quantity ranges shown in the chart.
- To defrost items not listed in AUTO DEFROST, use 20% cook power. See the microwave cookbook provided with your oven for defrosting information.

Weight conversion chart

You are probably used to food weights as being in pounds and ounces that are fractions of a pound (for example, 4 ounces equals $\frac{1}{4}$ pound). However, in order to enter food weight in AUTO DEFROST, you must specify pounds and tenths of a pound. If the weight on the food package is in fractions of a pound, you can use the following chart to convert the weight to decimals.

| NUMBER | AFTER DECIMAL | EQUIVALENT OUNCE WEIGHT |
|--------|----------------------|-------------------------|
| .10 | | 1.6 |
| .20 | | 3.2 |
| .25 | One-Quarter Pound | 4.0 |
| .30 | | 4.8 |
| .40 | | 6.4 |
| .50 | One-Half Pound | 8.0 |
| .60 | | 9.6 |
| .70 | | 11.2 |
| .75 | Three-Quarters Pound | 12.0 |
| .80 | | 12.8 |
| .90 | | 14.4 |
| 1.00 | One Pound | 16.0 |

Defrosting tips

- **When using AUTO DEFROST**, the weight to be entered is the net weight in pounds and tenths of pounds (the weight of the food minus the container).
- **Only use AUTO DEFROST** for raw food. AUTO DEFROST gives best results when food to be thawed is a minimum of 0°F. If food has been stored in a refrigerator-freezer that does not maintain a temperature of 0°F or below, always program a lower food weight (for a shorter defrosting time) to prevent cooking the food.
- **If the food is kept outside** the freezer for up to 20 minutes, enter a lower food weight.
- **If the food is kept outside** the freezer for more than 20 minutes, and for defrosting ready-made food, defrost by time and power (see chart in cookbook) and let stand after defrosting.
- **The shape of the package** alters the defrosting time. Shallow rectangular packets defrost more quickly than a deep block.
- **Separate pieces** as they begin to defrost. Separated pieces defrost more easily.
- **You can use small pieces** of aluminum foil to shield foods like chicken wings, leg tips, and fish tails, but the foil must not touch the side of the oven. Foil can damage the oven lining.
- **Shield areas of food** with small pieces of foil if they start to become warm.
- **For better results, a preset standing time** is included in the defrosting time. This may make the defrosting time seem longer than expected. (For more information on standing time, see "Cooking tips" on page 59.)

Using AUTO REHEAT

Cooking with AUTO REHEAT lets you reheat food without entering times or cook powers. AUTO REHEAT has preset times and cook powers for: Dinner Plate, Bread, Meats, Vegetables, Soups, and Sauce (see chart on page 42.) All you do is touch the Auto Reheat Pad until you reach the desired

category, or touch a Number Pad. Then you touch the Quantity Pad until you reach the desired quantity. Your microwave oven does the rest.

NOTE: See "Reheating chart" on page 57 when reheating with cooking time and cook power.

1. Put food in oven and close door.

2. Choose AUTO REHEAT.

TOUCH



YOU SEE



3. Choose food setting.

Keep touching AUTO REHEAT until the food that you are reheating appears on the Display. Or you can touch the Number Pad that goes with the food setting you want.

Example for Bread (Setting 2):

TOUCH



twice

YOU SEE



NOTE: To choose the desired food setting, see the Cook Guide Label on the front frame of the oven or the "Auto reheat chart" on page 42.

4. Enter food quantity.

Example for 2:

TOUCH



twice

YOU SEE



Touch START/ENTER or wait 5 seconds:

TOUCH



YOU SEE



COOKING WITH MICROWAVES ONLY

If you want to change reheating time, touch Number Pad 7 or 9 one to three times (see page 20 for more information).

NOTES:

- **Next time** you reheat this type of food with AUTO REHEAT, the oven will automatically reheat for the new time you have set. To change back to the original reheating time, touch Number Pad 8 after entering the quantity.
- **You can only change** reheating time before the countdown starts (immediately after you enter the quantity).

At end of reheating time:

TOUCH

9

three times
(example)

YOU SEE



(new reheating time)

YOU SEE



(four tones will sound)

5. After reheating, open the door OR TOUCH

PAUSE
CANCEL

YOU SEE



(time of day)

Auto reheat chart

| SETTING | FOOD | QUANTITY YOU CAN REHEAT |
|---------|--------------|-------------------------|
| 1 | Dinner Plate | 1-2 plates |
| 2 | Bread | 1-6 slices or rolls |
| 3 | Meats | 1-6 servings |
| 4 | Vegetables | 1-4 cups |
| 5 | Soups | 1-4 cups |
| 6 | Sauce | 1-3 cups |

Using POPCORN

POPCORN lets you pop commercially packaged microwave popcorn by touching just one pad. Pop only one package at a time. If you are using a microwave popcorn popper, follow manufacturer's instructions. Cooking performance may vary with brand. Try several brands to decide which gives best popping results. For best results, use fresh bags of popcorn.

NOTE: If you want to add more time after popping use COOK A BIT MORE. See page 24 for more information.

⚠ WARNING

Fire Hazard

- Do not try to repop unpopped kernels and do not reuse popcorn bags.
 - If you remove the turntable right after popping popcorn, use oven mitts.
- Failure to follow the above could result in fire or burns.

1. Place bag in center of turntable and close door.

2. Choose POPCORN.

TOUCH



YOU SEE



At end of popping time:

YOU SEE



(four tones will sound)

3. After popping popcorn, open the door.

OR TOUCH



YOU SEE



(time of day)

Using WARM HOLD

You can safely keep hot, cooked food warm in your microwave oven for up to 10 minutes. You can use WARM HOLD by itself, or to automatically follow a cooking cycle.

NOTES:

- **Do not** use WARM HOLD for more than 10 minutes. After 10 minutes, food will continue to cook.
- **Food cooked covered** should be covered during WARM HOLD.
- **Pastry items** (pies, turnovers, etc.) should be uncovered during WARM HOLD.
- **Complete meals** kept warm on a dinner plate should be covered during WARM HOLD.

1. Put hot, cooked food in oven and close the door.

2. Choose setting.

TOUCH

WARM
HOLD

YOU SEE

WARM

3. Start oven.

TOUCH

START
ENTER

YOU SEE

WARM

To make WARM HOLD automatically follow another cycle:

- **Just touch WARM HOLD** after you have chosen a cook function (before or after cooking has started).
- **When the last cooking cycle is over**, you will hear four tones. "WARM" will come on while the oven continues to run.
- **You can set WARM HOLD to follow** any cook function.

Using SIZZLE

SIZZLE lets you use microwaves to fry food in your CRISPWARE™ Crisper Pan. Use SIZZLE to fry bacon and eggs, sausages, and other similar foods. You must place food on the CRISPWARE™ Crisper Pan when using this function. (See “Utensils” on page 17 for more information about the Crisper Pan.) Microwaves near the food heat the Crisper Pan very rapidly to brown and crisp the bottom of your food, while microwaves above the food cook it from the top.

NOTES:

- **If you want to add more time during cooking use ADD MINUTE.** See page 24 for more information.
- **If you want to add more time after cooking use COOK A BIT MORE.** See page 24 for more information.

1. Place food on Crisper Pan, put pan on turntable, and close door.

NOTES:

- **The Crisper Pan** can be preheated before use.
- **Spray Crisper Pan** with nonstick cooking oil or brush pan with oil before use. This will make it easier to remove food from the pan and to clean pan after use.

2. Choose SIZZLE.

TOUCH



YOU SEE

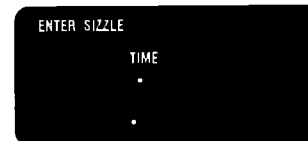

3. Set cooking time.

Example for 5 minutes:

TOUCH



YOU SEE



COOKING WITH MICROWAVES ONLY

4. Start oven.

TOUCH



YOU SEE



After 5 seconds:

YOU SEE



(display counts down cooking time)

At end of cooking time:

YOU SEE



(four tones will sound)

5. After cooking, open the door OR TOUCH



YOU SEE



(time of day)

Cooking with the Grill Element

This section gives you step-by-step instructions for operating each grill function. Please read these instructions carefully.

To get the best cooking results:

- **Always use the CRISPSWARE™ Crisper Pan** when cooking with CRISP. The Crisper Pan is specially designed for sizzling and crisping (see page 17 for more information).
- **The Crisper Pan** can be preheated before use.
- **Spray Crisper Pan** with nonstick cooking oil or brush pan with oil before use. This will make it easier to remove food from the pan and to clean pan after use.
- **Use the grilling rack** to place food closer to the grill element for faster cooking (see page 17 for more information).
- **If you want to add more time during cooking** use ADD MINUTE. See page 24 for more information.
- **If you want to add more time after cooking** use COOK A BIT MORE. See page 24 for more information.

⚠ WARNING

Burn Hazard

Do not touch the top of the microwave oven when grilling.

Failure to follow the above could result in burns.

Using CRISP

Use CRISP to bake or to cook food (for example, pizza crust) until it is crisp. Use it also to fry bacon and eggs, sausages, and other similar foods. You must place food on the CRISPWARE™ Crisper Pan when using this function. (See “Utensils” on page 17 for more information on the Crisper Pan.)

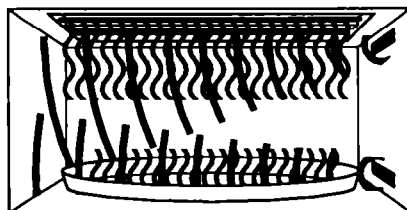

Microwaves near the food heat the Crisper Pan very rapidly to brown and crisp the bottom of your food, while the grill element cooks your food from the top. Additional microwaves above the food also heat it.

NOTE: “GRILL” will flash on the Display to tell you that the grill is heating up.

⚠ WARNING

Burn Hazard

Use oven mitts and Crisper Pan handle when removing the hot Crisper Pan. Use caution when allowing children to use Crisper Pan.

Failure to do so could result in burns.

1. Place food on Crisper Pan, put pan on turntable, and close door.

2. Choose CRISP.

TOUCH



YOU SEE



3. Set cooking time (optional).

Example for 10 minutes:

TOUCH

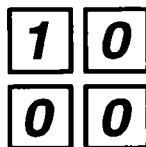

YOU SEE



4. Start oven.

TOUCH



YOU SEE



After 4 seconds:

YOU SEE



(display counts down cooking time)

At end of cooking time:

YOU SEE



(four tones will sound)

5. After cooking, open the door OR TOUCH



YOU SEE



(time of day)

Using AUTO CRISP

AUTO CRISP lets you cook food until it is crisp, without entering times or cook powers. AUTO CRISP has preset times and cook powers for: Frozen Pizza, Fresh Pizza, Frozen Potatoes, and Frozen Chicken (see chart on page 52). All you do is touch the Auto Crisp Pad until you reach the desired setting, or touch a Number Pad. Then you touch the Quantity Pad until you reach the desired quantity. Your microwave oven does the rest.

You must place food on the CRISPWARE™ Crisper Pan when using this function. (See “Utensils” on page 17 for more information on the Crisper Pan.) Microwaves near the food heat the Crisper Pan very rapidly to brown and crisp the bottom of your food, while the grill element cooks your food from the top. Additional microwaves above the food also heat it.

1. Place food on CRISPWARE Crisper Pan, put pan on turntable, and close door.

2. Choose AUTO CRISP.

TOUCH



YOU SEE



3. Choose setting.

Keep touching AUTO CRISP until the food that you are crisping appears on the Display. Or you can touch the Number Pad that goes with the food setting you want.

Example for Frozen Pizza (Setting 1):

TOUCH



once

YOU SEE



NOTE: To choose the desired food setting, see the Cook Guide Label on the front frame of the oven or the “Auto crisp chart” on page 52.

4. Choose size (or weight).

Example for 12":

TOUCH

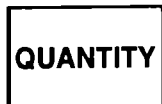

once

YOU SEE



Touch START/ENTER or wait 5 seconds:

TOUCH



YOU SEE



(display counts down cooking time)

If you want to change cooking time, touch Number Pad 7 or 9 one to three times (see page 20 for more information).

NOTES:

- **Next time** you cook this type of food with AUTO COOK, the oven will automatically cook for the new time you have set. To change back to the original cooking time, touch Number Pad 8 after entering the quantity.
- **You can only change** cooking time before the countdown starts (immediately after you enter the quantity).

TOUCH



three times
(example)

YOU SEE



(new cooking time)

COOKING WITH THE GRILL ELEMENT

At end of cooking time:

YOU SEE

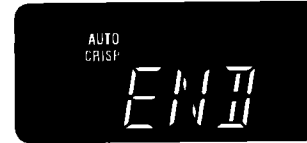

(four tones will sound)

5. After cooking, open the door OR TOUCH



YOU SEE



(time of day)

Auto crisp chart

| SETTING | FOOD | SIZE |
|---------|-----------------|---|
| 1 | Frozen Pizza | 12, 8, 9, or 10 in |
| 2 | Fresh Pizza | 12, 8, 9, or 10 in (needs 2 minutes prebaking of pizza dough) |
| 3 | Frozen Potatoes | .5, 1, 1.5 lb |
| 4 | Frozen Chicken | .5, 1, 1.5 lb |

Using GRILL

GRILL lets you cook hamburgers, sausages, steaks, and cutlets so they taste and look like they were cooked on an outdoor grill. The grill element in the oven ceiling will quickly broil your food.

NOTES:

- **If you need to put** food in a utensil, it is best to use the CRISPWARE™ Crisper Pan. Other utensils can melt or be a fire hazard.
- **For faster grilling of small amounts of food,** use the Grilling Rack provided with your oven. (See "Utensils" on page 17 for more information.)
- **For best results,** reposition food and turn over halfway through cooking.
- **Do not leave** the oven open for long periods when the grill is in operation. This will cause temperature to drop.
- **You cannot use GRILL** if the oven is already running.

COOKING WITH THE GRILL ELEMENT

1. Put food in oven and close door.

2. Choose GRILL.

TOUCH



YOU SEE

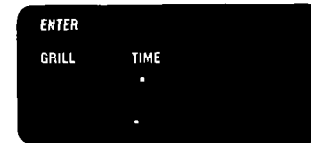

3. Set cooking time.

Example for 5 minutes:

TOUCH



YOU SEE



4. Start oven.

TOUCH



YOU SEE



(display will count down cooking time)

At end of cooking time:

YOU SEE



(four tones will sound)

5. After cooking, open the door OR

TOUCH



YOU SEE



(time of day)

Combination grill/microwave cooking

You can cook with the grill element part of the time and with microwaves the other part of the time by setting each function separately.

To set up combination cooking:

1. **Touch MICROWAVE.**
2. **Touch** Number Pads to set microwave cooking time.
3. **Touch** COOK POWER as many times as needed or touch a Number Pad to set cook power.

4. **Touch** GRILL.

5. **Touch** Number Pads to set grilling time.

6. **Touch** START/ENTER.

NOTES:

- **Make sure** utensils are oven-proof and allow microwaves to pass through them.
- **Make sure** food, containers, and coverings do not come in direct contact with oven wall or ceiling.

Choosing the proper utensil materials

This chart tells you which utensil materials can be used in each type of cooking.

| MATERIAL | GRILL COOKING | MICROWAVE COOKING | COMBINED COOKING |
|--|---------------|-------------------|------------------|
| Glass (General) | No | Yes (1) | No |
| Glass (Heat-Resistant) | Yes | Yes | Yes |
| Glass-Ceramic And Ceramic (Heat-Resistant) | Yes | Yes (1) | Yes (1) |
| Earthenware | Yes | Yes | Yes |
| China (Heat-Resistant) | Yes | Yes | Yes |
| Plastic (General) | No | Yes (2) | No |
| Plastic (Heat-Resistant) | No | Yes (2) | No |
| Aluminum Foil Containers/Alumi- num Foil | Yes | Yes (3) | Yes |
| Metal (Pots, Pans, etc.) | Yes | No | No |
| Paper | No | Yes | No |

(1) Without metal parts or metal trims.

(2) Some plastics are heat-proof only to certain temperatures.

(3) You can use aluminum foil to shield delicate areas of food. (This prevents overcooking.)

Caring for Your Microwave Oven

To make sure your microwave oven looks good and works well for a long time, you should maintain it properly. To do so, please follow these instructions carefully.

NOTES:

- Your **VIP CRISPWAVE™** microwave oven has a stainless steel interior. Unlike the painted steel interiors found in most other microwave ovens, the surface will not chip, rust, or corrode.
- **Do not use** metal scouring pads on inside of oven cavity. They will scratch the surface.

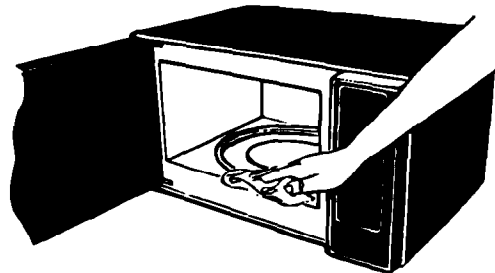

Be sure to keep the areas clean where the door and oven frame touch when closed. Use only mild, nonabrasive soaps or detergents applied with a sponge or paper towel when cleaning surfaces. Wipe well with clean water.

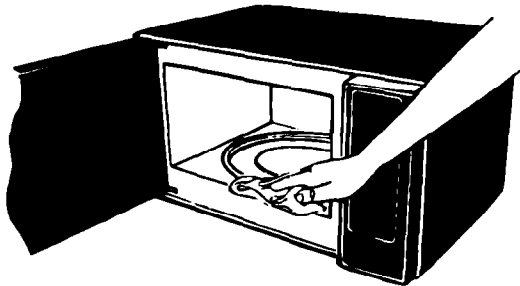

Wipe often with warm, sudsy water and a sponge or paper towel. You can remove the glass turntable to clean the oven cavity floor; however, this oven is designed to operate with the turntable in place. **Do not** operate the microwave oven when turntable is removed for cleaning. See page 8 for further information about the turntable.

NOTE: Abrasive cleansers, steel-wool pads, gritty wash cloths, etc., could damage the control panel, and the interior and exterior oven surfaces. Use a sponge with a mild detergent or a paper towel with spray glass cleaner. Apply spray glass cleaner to paper towel; do not spray directly on oven.

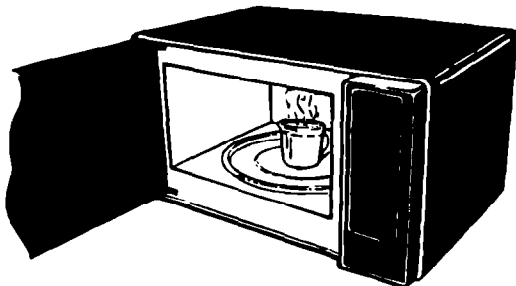

For stubborn soil, **boil** a cup of water in the oven for 2 or 3 minutes. Steam will soften the soil. To get rid of odors inside the oven, **boil** a cup of water with lemon juice.

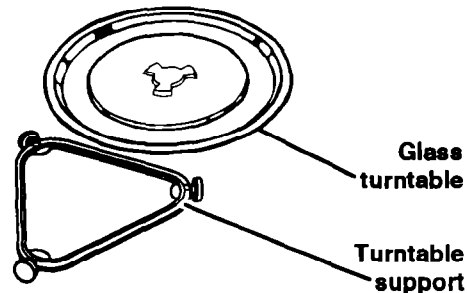

To clean turntable and turntable support, wash in mild, sudsy water; for heavily soiled areas **use** a mild cleanser and scouring sponge. The turntable and turntable support are dishwasher-safe.

CARING FOR YOUR MICROWAVE OVEN

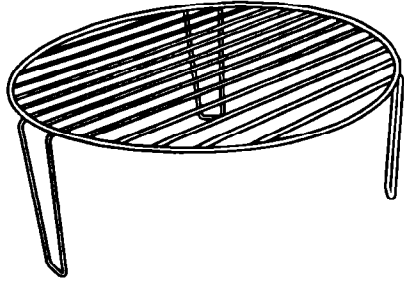

To clean the Grilling Rack, wash with steel-wool pad and warm, soapy water. Rack is dishwasher-safe.

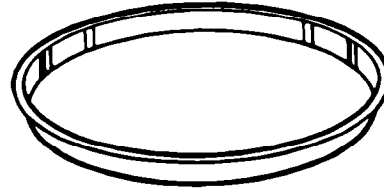

To clean CRISPWARE™ Crisper Pan, wash in mild, sudsy water; for heavily soiled areas use a mild cleanser and scouring sponge. Pan is dishwasher-safe.

Cooking Guide

Reheating chart

Times are approximate and may need to be adjusted to individual tastes. **NOTE:** For reheating with preset times and cook powers, see "Using AUTO REHEAT" on page 41.

| ITEM | STARTING TEMP | TIME/POWER | PROCEDURE |
|--|--|--|--|
| Meat (Chicken pieces, chops, hamburgers, meat loaf slices) 1 serving 2 servings | Refrigerated Refrigerated | 1-2 min at 70% 2½-4½ min at 70% | Cover loosely. (Do not cover when grilling.) |
| Meat Slices (Beef, ham, pork, turkey) 1 or more servings | Room temp Refrigerated | 45 sec-1 min per serving at 50% 1-3 min per serving at 50% | Cover with gravy or wax paper. (Do not cover when grilling.) Check after 30 sec per serving. |
| Stirrable Casseroles and Main Dishes 1 serving 2 servings 4-6 servings | Refrigerated Refrigerated Refrigerated | 2-4 min at 100% 4-6 min at 100% 6-8 min at 100% | Cover. Stir after half the time. |
| Nonstirrable Casseroles and Main Dishes 1 serving 2 servings 4-6 servings | Refrigerated Refrigerated Refrigerated | 5-8 min at 50% 9-12 min at 50% 13-16 min at 50% | Cover with wax paper. |
| Soup, Cream 1 cup 1 can (10¾ oz) | Refrigerated Room temp | 3-4½ min at 50% 5-7 min at 50% | Cover. Stir after half the time. |
| Soup, Clear 1 cup 1 can (10¾ oz) | Refrigerated Room temp | 2½-3½ min at 100% 4-5½ min at 100% | Cover. Stir after half the time. |
| Pizza 1 slice 1 slice 2 slices 2 slices | Room temp Refrigerated Room temp Refrigerated | 15-25 sec at 100% 30-40 sec at 100% 30-40 sec at 100% 45-55 sec at 100% | Place on preheated CRISPWARE™ Crisper Pan. |
| Vegetables 1 serving 2 servings | Refrigerated Refrigerated | ¾-1½ min at 100% 1½-2½ min at 100% | Cover. Stir after half the time. |
| Baked Potato 1 2 | Refrigerated Refrigerated | 1-2 min at 50% 2-3 min at 50% | Cut potato lengthwise and then several times crosswise. Cover with wax paper. |
| Breads (Dinner or breakfast roll) 1 roll 2 rolls 4 rolls | Room temp Room temp Room temp | 8-12 sec at 50% 11-15 sec at 100% 18-22 sec at 100% | Wrap single roll, bagel, or muffin in paper towel. To reheat several, line plate with paper towel. Cover with another paper towel. |
| Pie Whole 1 slice | Refrigerated Refrigerated | 5-7 min at 70% 30 sec at 100% | |

Microwave cooking chart

Times are approximate and may need to be adjusted to individual taste.

NOTE: For cooking with preset times and cook powers, see "Using AUTO COOK" on page 34.

| <u>MEATS, POULTRY, FISH, SEAFOOD</u> Allow standing time after cooking. | | | <u>VEGETABLES (continued)</u> Cook at 100% cook power. | | |
|---|----------------------------|---|--|---|----------------------|
| FOOD | COOK POWER | TIME | FOOD | TIME | |
| Bacon | 100% | 45 sec to 1 min 15 sec per slice | Carrots (1 lb) | 8-12 min | |
| Ground Beef For Casseroles (1 lb) | 100% | 4-6 min | Cauliflower (medium head) | 6-9 min | |
| Hamburger Patties (2) | 100% | 1st side 2 min 2nd side 1½ to 2½ min | Corn On The Cob (2) (4) | 4-9 min 6-16 min | |
| Hamburger Patties (4) | 100% | 1st side 2½ min 2nd side 2-3 min | Potatoes, Baked (4 medium) | 13-19 min | |
| Meat Loaf (1½ lbs) | 100% | 13-19 min | Squash, Summer (1 lb) | 3-8 min | |
| Chicken Pieces Internal temperature should be 185°F after standing. | 100% | 6-9 min/lb | <u>OTHER</u> | | |
| Turkey Breast | 100% then 70% | 5 min 8-12 min/lb | Applesauce (4 servings) | 100% 7-10 min | |
| Fish Fillets (1 lb) | 100% | 5-6 min | Baked Apples (4) | 100% 4-6 min | |
| Scallops And Shrimp (1 lb) | 100% | 3½-5½ min | Chocolate (melt 1 square) | 50% 1-2 min | |
| <u>VEGETABLES</u> Cook at 100% cook power. | | | Eggs, Scrambled (2) (4) | 100% 1 min 15 sec to 1 min 45 sec 2-3 min | |
| FOOD | | TIME | FOOD | COOK POWER | TIME |
| Beans, Green Or Yellow (1 lb) | | 6-12 min | Hot Cereals (1 serving) (4 servings) | 100% | 1½-5 min 4½-7 min |
| Broccoli (1 lb) | | 6-10 min | Nachos (large plate) | 50% | 1½-2½ min |
| | | | Water For Beverage (1 cup) (2 cups) | 100% | 2½-4 min 4½-6 min |

Cooking tips

Amount of food

- **The more food** you prepare, the longer it takes. A rule of thumb is that a double amount of food requires almost double the time. If one potato takes four minutes to cook, you need about seven minutes to cook two potatoes.

Starting temperature of food

- **The lower the temperature** of the food being put into the microwave oven, the longer it takes to cook. Food at room temperature will be reheated more quickly than food at refrigerator temperature.

Composition of food

- **Food with a lot of fat and sugar** will be heated faster than food containing a lot of water. Fat and sugar will also reach a higher temperature than water in the cooking process.
- **The more dense the food**, the longer it takes to heat. "Very dense" food like meat takes longer to reheat than lighter, more porous food like sponge cakes.

Size and shape

- **Smaller pieces of food** will cook faster than larger pieces and same-shaped pieces of food cook more evenly than irregularly shaped foods.
- **With unevenly shaped foods**, the thinner parts will cook faster than the thicker areas. **Place** the thinner parts of chicken wings and legs in the center of the dish.

Stirring, turning foods

- **Stirring and turning foods** distributes heat quickly to the center of the dish and avoids overcooking at the outer edges of the food.

Covering food

Cover food to:

- **Reduce splattering**
- **Shorten cooking times**
- **Retain food moisture**

All coverings that allow microwaves to pass through are suitable. (See "Choosing the proper utensil materials" on page 54.)

Releasing pressure in foods

- **Several foods** (for example: baked potatoes, sausages, egg yolks, and some fruits) are tightly covered by a skin or membrane. This can cause the food to burst from steam building up in them during cooking. To relieve the pressure and to prevent bursting, **prick** these foods with a fork, cocktail pick, or toothpick.

NOTE: Food cooked in the CRISPWARE™ Crisper Pan will not burst and does not need to be pricked.

Using standing time

- **Always allow food to stand** for a while after cooking. Standing time after defrosting, cooking, or reheating always improves the result since the temperature will then be evenly distributed throughout the food.
- **When cooking in a microwave oven**, food continues to cook even when the microwave energy is turned off. Food is no longer cooked by microwaves, but it is still being cooked by the high heat left over from the microwave oven.
- **The length of the standing time** depends on the volume and density of the food. Sometimes it can be as short as the time it takes you to remove the food from the oven and take it to the serving table. However, with larger, denser food, the standing time may be as long as 10 minutes.

Arranging food

For best results, distribute food evenly on the plate. You can do this in several ways:

- **If you are cooking several items of the same food**, such as baked potatoes, **place** them in a ring pattern for uniform cooking.
- **When cooking foods of uneven shapes or thickness**, **place** the smaller or thinner area of the food towards the center of the dish where it will be heated last.
- **Arrange uneven foods**, such as fish, in the oven with the tails to the center.
- **If you are saving a meal in the refrigerator** or “plating” a meal for reheating, **arrange** the thicker, denser foods to the outside of the plate and the thinner or less dense foods in the middle.
- **Place thin slices** of meat on top of each other or interlace them.
- **Place thicker slices of meat**, such as meat loaf and sausages close to each other.
- **Reheat gravy or sauce** in a separate container.
- **Choose a tall, narrow container** rather than a low and wide container. When reheating gravy, sauce, or soup, do not fill the container more than $\frac{3}{4}$.
- **When you cook or reheat whole fish**, **score** the skin – this prevents cracking.
- **Shield the tail and head of whole fish** with small pieces of foil to prevent overcooking and ensure the foil does not touch the sides of the oven.
- **Do not** let food or container touch the top or sides of the oven. This will prevent possible arcing.

Using aluminum foil

Metal containers usually should not be used in a microwave oven. There are, however, some exceptions. If you have purchased food which is prepackaged in an aluminum foil container, then refer to the instructions on the package. It is possible to use disposable containers, but it generally takes longer and the final result will not be as good as if

food were placed in plastic or paper containers. If you use aluminum containers without package instructions, follow these guidelines:

- **Do not place** container on the wire Grilling Rack. Sparking may occur.
- **Place** container in a glass bowl and add some water so that it covers the bottom of the container, not more than $\frac{1}{4}$ inch high. This ensures even heating of the container bottom.
- **Always remove** the lid to avoid damage to the oven.
- **Use only** undamaged containers.
- **Do not use** containers taller than $\frac{3}{4}$ inch.
- **Container must be** half filled.
- **To avoid sparking**, there must be a minimum $\frac{1}{4}$ inch between the aluminum container and the walls of the oven and also between two aluminum containers.
- **Always place** container on turntable.
- **Thickness of the food layer** must be greater than thickness of the aluminum.
- **Reheating food** in aluminum foil containers usually takes up to double the time compared to reheating in plastic, glass, china, or paper containers. The time when food is ready will vary a great deal.
- **Let food stand** for 2-3 minutes after heating so that heat is spread evenly throughout container.

NOTE: Because of the unique design of the aluminum CRISPWARE™ Crisper Pan and the Double Emission System, the Crisper Pan is safe to use in your microwave oven.

Cooking you should not do in your microwave oven

- **Do not** do canning of foods in the oven. Closed glass jars may explode, resulting in damage to the oven or possible personal injury.
- **Do not** use the microwave oven to sterilize objects (baby bottles, etc.). It is difficult to maintain the high temperature required for safe sterilization.

Questions and Answers

| QUESTIONS | ANSWERS |
|---|--|
| Can I operate my microwave oven without the turntable or turn the turntable over to accommodate a large dish? | No. If you remove or turn over the turntable, you will get poor cooking results. Dishes used in your oven must fit on the turntable. |
| Can I use a rack in my microwave oven so that I may reheat or cook on two levels at a time? | You can use a rack only if rack is supplied with your microwave oven. Use of any rack not supplied with the microwave oven can result in poor cooking performance and/or arcing. |
| Can I use either metal or aluminum pans for microwave cooking? | Useable metal includes aluminum foil for shielding (use small, flat pieces), small skewers, and shallow foil trays (if tray is 3/4 inch deep and filled with food to absorb microwave energy). When crisping or using SIZZLE, use the specially designed CRISPWARE™ Crisper Pan that comes with your oven. Never allow metal to touch walls or door. (For more information, see page 60.) |
| Is it normal for the turntable to turn in either direction? | Yes. The turntable rotates clockwise or counter-clockwise, depending on the rotation of the motor when the cooking cycle begins. |
| Sometimes the door of my microwave oven appears wavy. Is this normal? | This appearance is normal and does not affect the operation of your oven. |
| What are the humming noises that I hear when my microwave oven is operating? | You hear the sound of the transformer when the magnetron tube cycles on. |
| Why does the dish become hot when I microwave food in it? I thought that this should not happen. | As food becomes hot it will conduct the heat to the dish. Also, when grilling remember that the Crisper Pan is made of a special material that absorbs microwave energy, making the pan very hot for browning. To avoid burns, use hot pads or the Crisper Pan handle to remove food after cooking and grilling. |
| What does "standing time" mean? | "Standing time" means that food should be taken out of the oven and covered after cooking. This process allows the cooking to finish, saves energy, and frees the oven for another purpose. |
| Can I pop popcorn in my microwave oven? How do I get the best results? | Yes. Pop packaged microwave popcorn following manufacturer's guidelines or use the preprogrammed Popcorn pad. Do not use regular paper bags. Use the "listening test" by stopping the oven when the popping slows to a "pop" every one or two seconds. Do not try to repop unpopped kernels. You can also use special microwave poppers. When using a popper, be sure to follow manufacturer's directions. Do not pop popcorn in glass utensils. |

QUESTIONS AND ANSWERS

| QUESTIONS | ANSWERS |
|--|--|
| How does my CRISPWARE™ Crisper Pan aid browning and crisping? | The bottom of your Crisper Pan is coated with a special material that absorbs the magnetic part of the microwave energy. This material becomes very hot and transfers heat to the bottom of the Crisper Pan for higher temperature cooking. |
| The top of my oven turns red when I use CRISP, GRILL, or AUTO CRISP. Is this normal? | Yes. The Quartz Grill Element in the ceiling of your oven gets very hot, causing the red glow. But because your microwave oven is made of special heat-resistant materials, it will not burn or melt. You should not, however, touch the top of the oven because it is hot enough to burn you. |
| Sometimes I notice sparking when grilling. What causes this? | Sparking is caused by the burning off of fat from past cooking. It will stop when fat is all burned off of the oven. |

Troubleshooting

Most cooking problems often are caused by little things you can find and fix without tools of any kind. Check the lists below and on the next page before calling for assistance or service. If you still need help, see "Requesting Assistance or Service" on page 65.

If nothing operates, check the following:

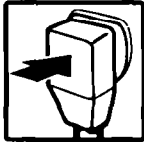

Is the microwave oven plugged into a live outlet with the proper voltage?
(See Installation Instructions.)

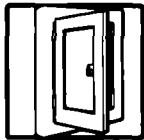

Have you blown a household fuse or tripped a circuit breaker?



Has the electric company experienced a power failure?



Other possible problems and their causes:

| PROBLEM | CAUSE |
|--|--|
| The microwave oven will not run | <ul style="list-style-type: none">• The door is not firmly closed and latched.• You did not touch START/ENTER.• You did not follow directions exactly.• An operation that was programmed earlier is still running. |
| Microwave cooking times seem too long | <ul style="list-style-type: none">• The electric supply to your home or wall outlets is low or lower than normal. Your electric company can tell you if the line voltage is low. Your electrician or service technician can tell you if the outlet voltage is low.• The cook power is not at the recommended setting. Check "Microwave cooking chart" on page 58.• There is not enough cooking time for the amount of food being cooked. |



| PROBLEM | CAUSE |
|---|---|
| The turntable will not turn | <ul style="list-style-type: none">• The turntable is not correctly in place. Make sure the turntable is correct-side up and is sitting securely on center shaft.• The support is not operating correctly. Call an authorized Whirlpool service technician for repair. Cooking without the turntable can give you poor results. |
| The Display shows a time counting down but the oven is not cooking | <ul style="list-style-type: none">• The oven door is not closed completely.• You have set the controls as a kitchen timer. Touch PAUSE/CANCEL to cancel the Minute Timer. |
| You do not hear the Programming Tone | <ul style="list-style-type: none">• The command is not correct. |
| The fan seems to be running slower than usual | <ul style="list-style-type: none">• The oven has been stored in a cold area. The fan will run slower until the oven warms up to normal room temperature. |

If none of these items was causing your problem, see "Requesting Assistance or Service" on page 65.

Requesting Assistance or Service

Before calling for assistance or service, please check "Troubleshooting" on pages 63-64. It may save you the cost of a service call. If you still need help, follow the instructions below.

1. If you need assistance* ...

Call Whirlpool Consumer Assistance Center telephone number. Dial toll-free from anywhere in the U.S.A.:



1-800-253-1301

and talk with one of our trained consultants. The consultant can instruct you in how to obtain satisfactory operation from your appliance or, if service is necessary, recommend a qualified service company in your area.

If you prefer, write to:

Mr. William Clark
Consumer Assistance Representative
Whirlpool Corporation
2000 North M-63
Benton Harbor, MI 49022-2692

Please include a daytime phone number in your correspondence.

2. If you need service* ...

Whirlpool has a nationwide network of authorized Whirlpool service companies. Whirlpool service technicians are trained to fulfill the product warranty and provide after-warranty service, anywhere in the United States. To locate the authorized Whirlpool service company in your area, call our Consumer Assistance Center telephone number (see Step 1) or look in your telephone directory Yellow Pages under:

• APPLIANCE-HOUSEHOLD-MAJOR, SERVICE & REPAIR

- See: Whirlpool Appliances or Authorized Whirlpool Service
(Example: XYZ Service Co.)

• WASHING MACHINES & DRYERS, SERVICE & REPAIR

- See: Whirlpool Appliances or Authorized Whirlpool Service
(Example: XYZ Service Co.)

3. If you are not satisfied with how the problem was solved ...

- Contact the Major Appliance Consumer Action Program (MACAP). MACAP is a group of independent consumer experts that voices consumer views at the highest levels of the major appliance industry.
- Contact MACAP only when the dealer, authorized servicer, and Whirlpool have failed to resolve your problem.

Major Appliance Consumer Action Program
20 North Wacker Drive
Chicago, IL 60606

- MACAP will in turn inform us of your action.

*When asking for help or service:

Please provide a detailed description of the problem, your appliance's complete model and serial numbers, and the purchase date. (See page 3.) This information will help us respond properly to your request.

Index

This index is alphabetical. It contains all the topics included in this manual, along with the page(s) on which you can find each topic.

| <u>TOPIC</u> | <u>PAGE</u> | <u>TOPIC</u> | <u>PAGE</u> |
|---|----------------|---|--|
| ALUMINUM FOIL | 60, 61 | ERROR SIGNALS | 15 |
| AUDIBLE SIGNALS | 16 | GROUNDING INSTRUCTIONS | 10 |
| BUILT-IN KITS | 9, 18 | HOW YOUR MICROWAVE OVEN WORKS | 11, 12 |
| CARING FOR YOUR MICROWAVE OVEN | 55 | INSTALLATION INSTRUCTIONS | 9 |
| CHARTS | | PARTS AND FEATURES | |
| Auto cook | 36 | Control panel | 14-16 |
| Auto crisp | 52 | Cook guide label | 13 |
| Auto defrost | 39 | Crisper pan | 7, 12, 17, 45, 47, 48, 50, 52, 56, 59, 60, 61, 62 |
| Auto reheat | 42 | Door handle | 13 |
| Microwave cooking | 58 | Door safety lock system | 13 |
| Reheating | 57 | Double Emission System | 11, 12, 60 |
| Utensil materials | 54 | Grill element | 13, 62 |
| Weight conversion | 40 | Grilling rack | 17, 52, 56 |
| CONTROL FUNCTIONS | | Light | 13 |
| ADD MINUTE | 24 | Magnetron | 11, 61 |
| AUTO COOK | 34 | Model and serial number plate | 13 |
| AUTO CRISP | 50 | Turntable | 8, 11, 13, 55, 61 |
| AUTO DEFROST | 37 | Utensils | 17 |
| AUTO REHEAT | 41 | Vents | |
| Changing cooking times | 20 | (exhaust & air intake openings) | 9, 13 |
| Child lock | 16 | Window | 13 |
| CLOCK | 18 | QUESTIONS AND ANSWERS | 61 |
| Combination grill/microwave cooking ... | 54 | RACK | 61 |
| COOK A BIT MORE | 24 | RADIO INTERFERENCE | 12 |
| Cooking at high cook power | 28 | REQUESTING ASSISTANCE OR SERVICE | 65 |
| Cooking at lower cook powers | 29 | SAFETY | 4-8 |
| COOK POWER | 29, 58 | STANDING TIME | 40, 59, 61 |
| CRISP | 48 | TIPS | |
| GRILL | 52 | Cooking | 59 |
| Interrupting cooking | 16 | Defrosting | 40 |
| MICROWAVE | 32, 54 | TROUBLESHOOTING | 63, 64 |
| Multi-cycle cooking | 31 | WARRANTY | 68 |
| PAUSE/CANCEL | 16, 25 | WATTAGE | 27 |
| Personal choice | 25 | | |
| POPCORN | 25, 43 | | |
| QUANTITY | 34, 38, 41, 51 | | |
| SIZZLE | 45 | | |
| START/ENTER | 16 | | |
| TIMER SET/OFF | 19 | | |
| WARM HOLD | 44 | | |

WHIRLPOOL® Microwave Oven Warranty

| LENGTH OF WARRANTY | WHIRLPOOL WILL PAY FOR |
|---|--|
| FULL ONE-YEAR WARRANTY From Date of Purchase | FSP® replacement parts and repair labor to correct defects in materials or workmanship. Service must be provided by an authorized Whirlpool service company. |
| LIMITED FOUR-YEAR WARRANTY Second Through Fifth Year From Date of Purchase | FSP replacement magnetron tube on microwave ovens if defective in materials or workmanship. |
| WHIRLPOOL WILL NOT PAY FOR | |
| <p>A. Service calls to:</p> <ol style="list-style-type: none"> 1. Correct the installation of your microwave oven. 2. Instruct you how to use your microwave oven. 3. Replace house fuses or correct house wiring. 4. Replace owner-accessible light bulbs. <p>B. Repairs when your microwave oven is used in other than normal, single-family household use.</p> <p>C. Pickup and delivery. Your microwave oven is designed to be repaired in the home.</p> <p>D. Damage to your microwave oven caused by accident, misuse, fire, flood, acts of God, or use of products not approved by Whirlpool.</p> <p>E. Any labor costs during limited warranty.</p> <p>F. Repairs to parts or systems caused by unauthorized modifications made to the appliance.</p> | |

3/95

WHIRLPOOL CORPORATION SHALL NOT BE LIABLE FOR INCIDENTAL OR CONSEQUENTIAL DAMAGES. Some states do not allow the exclusion or limitation of incidental or consequential damages, so this exclusion or limitation may not apply to you. This warranty gives you specific legal rights, and you may also have other rights which vary from state to state.

Outside the United States, a different warranty may apply. For details, please contact your authorized Whirlpool distributor or military exchange.

If you need service, first see the "Requesting Assistance or Service" section of this book. After checking "Requesting Assistance or Service," additional help can be found by calling our Consumer Assistance Center telephone number, **1-800-253-1301**, from anywhere in the U.S.A.

PART NO. 461969404801/4375205

© 1995 Whirlpool Corporation

© Registered Trademark/TM Trademark of Whirlpool, U.S.A.

Printed in Sweden